

String Inverter (SUN2000-33/36/40KTL-US)



Smart

- 4 MPPTs for versatile adaptations to different layouts
- 8 strings intelligent monitoring and fast trouble-shooting
- Power Line Communication (PLC) supported
- Smart String I-V Diagnosis supported

Safe

- DC AFCI compliant to UL 1699B
- DC disconnect integrated, safe and convenient for maintenance
- Category surge arresters for both DC and AC
- Ground fault protection
- Residual Current Detection (RCD) protection

Efficient

- Max. efficiency 98.9%, CEC. efficiency 98.5%

Reliable

- Natural cooling technology
- Protection rating of NEMA 4X

Efficiency Curve

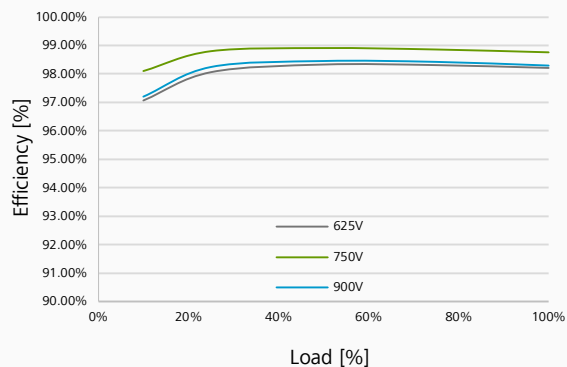

Circuit Diagram

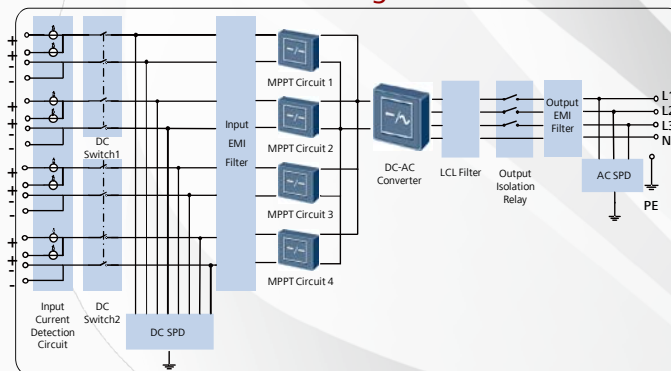

SUN2000-33/36/40KTL-US



String Inverter (SUN2000-33/36/40KTL-US)



| Technical Specifications | SUN2000-33KTL-US | SUN2000-36KTL-US | SUN2000-40KTL-US |
|--|--|------------------------------|------------------------------|
| Efficiency | | | |
| Max. Efficiency | 98.9% | 98.9% | 98.9% |
| CEC. Efficiency | 98.5% | 98.5% | 98.5% |
| Input | | | |
| Max. Input Voltage | 1,000 V | 1,000 V | 1,000 V |
| Max. Current per MPPT | 22 A | 22 A | 22 A |
| Max. Short Circuit Current per MPPT | 30 A | 30 A | 30 A |
| Min. Start Input Voltage | 250 V | 250 V | 250 V |
| Full Power MPPT Voltage Range | 460 V – 850 V | 490 V – 850 V | 530 V – 850 V |
| MPPT Operating Voltage Range | 200 V - 1000 V | 200 V - 1000 V | 200 V - 1000 V |
| Rated Input Voltage | 720 V | 720 V | 720 V |
| Max. Number of Inputs | 8 | 8 | 8 |
| Number of MPP Trackers | 4 | 4 | 4 |
| Output | | | |
| Rated AC Active Power | 33,300 W | 36,000 W | 40,000 W |
| Max. AC Apparent Power | 36,600 VA | 40,000 VA | 44,000 VA |
| Max. AC Active Power (cosφ=1) | 36,600 W | 40,000 W | 44,000 W |
| Rated Output Voltage | 277V / 480V, 3W+PE / 3W+N+PE | 277V / 480V, 3W+PE / 3W+N+PE | 277V / 480V, 3W+PE / 3W+N+PE |
| Rated Output Current | 40.1 A | 43.4 A | 48.2 A |
| Rated AC Grid Frequency | 60 Hz | 60 Hz | 60 Hz |
| Max. Output Current | 44.1 A | 48.2 A | 53 A |
| Adjustable Power Factor | 0.8 LG ... 0.8 LD | 0.8 LG ... 0.8 LD | 0.8 LG ... 0.8 LD |
| Max. Total Harmonic Distortion | < 3% | < 3% | < 3% |
| Protection | | | |
| Input-side Disconnection Device | Yes | | |
| Anti-Islanding Protection | Yes | | |
| DC Reverse-Polarity Protection | Yes | | |
| PV-array String Fault Monitoring | Yes | | |
| DC Surge Arrester | Category C | | |
| AC Surge Arrester | Category C | | |
| Insulation Monitoring | Yes | | |
| Residual Current Detection | Yes | | |
| Communication | | | |
| Display | LED Indicators | | |
| USB / Bluetooth +APP | Yes | | |
| RS485 | Yes | | |
| PLC | Yes | | |
| General | | | |
| Dimensions (W×H×D) | 36.6 x 21.7 x 10.2 inches (930 × 550 × 260 mm) | | |
| Weight | 121 lb. (55 kg) | | |
| Operation Temperature Range | -40°F ~ 140°F (-40°C ~ 60 °C) | | |
| Cooling | Natural Convection | | |
| Max. Operating Altitude Without Derating | 16,404 ft. (5,000 m) | | |
| Relative Humidity | 0 ~ 100% | | |
| DC Connector | Amphenol Helios H4 | | |
| AC Connector | Waterproof PG Terminal + OT Connector | | |
| Protection Rating | NEMA 4X | | |
| Internal Consumption at Night | < 1 W | | |
| Topology | Transformerless | | |
| Standards Compliance | | | |
| Safety /EMC | UL 1741, UL 1699B, UL 1998, CSA C22.2 #107.1-01, FCC Part 15 | | |
| Grid Code | IEEE 1547, IEEE 1547.1 | | |

Always Available for Highest Yields



www.huawei.com/solar
US 20161020