

A Important Safety Information

This Guide is intended for anyone who needs to operate, configure, and troubleshoot the Conext Automatic Generator Start (AGS). Certain configuration tasks should only be performed by qualified personnel in consultation with your local utility and/or an authorized dealer. Electrical equipment should be installed, operated, serviced, and maintained only by qualified personnel. Servicing of batteries must only be performed or supervised by qualified personnel with knowledge of batteries and their required precautions.

Qualified personnel have training, knowledge, and experience in:

- Installing electrical equipment
- Applying applicable installation codes
- Analyzing and reducing the hazards involved in performing electrical work
- Installing and configuring batteries
- Selecting and using Personal Protective Equipment (PPE)

No responsibility is assumed by Schneider Electric for any consequences arising out of the use of this material.

1. **Before using the AGS, read all instructions and cautionary markings on the unit, the generator, and all appropriate sections of this manual.**
2. Use of accessories not recommended or sold by the manufacturer may result in a risk of fire, electric shock, or injury to persons.
3. The AGS is designed to be permanently connected to the Xanbus network and to a generator. The manufacturer recommends that all wiring be done by a certified technician or electrician to ensure adherence to the local and national electrical codes applicable in your jurisdiction.
4. To avoid a risk of fire and electric shock, make sure that existing wiring is in good condition and that wire is not undersized. Do not operate the AGS with damaged or substandard wiring.
5. Do not operate the AGS if it has been damaged in any way.
6. This unit does not have any user-serviceable parts. Do not disassemble the AGS except where noted for connecting wiring and cabling. See your warranty for instructions on obtaining service. Attempting to service the unit yourself may result in a risk of electrical shock or fire. Internal capacitors remain charged after all power is disconnected.
7. Disable the generator's starting circuit by disconnecting the starter battery, spark plug, and so on, before wiring the device.
8. To reduce the risk of electrical shock, disconnect connections from the AGS before attempting any maintenance or cleaning or working on any components. Putting the unit in Standby mode will not reduce this risk.
9. Disable the automatic starting circuit and/or disconnect the generator from its starting battery to prevent accidental starting while performing maintenance.
10. Do not expose this unit to rain, snow, or liquids of any type. This product is designed for indoor use only. Damp environments will significantly shorten the life of this product and corrosion caused by dampness will not be covered by the product warranty.
11. To reduce the chance of short-circuits, always use insulated tools when installing or working with this equipment.
12. Remove personal metal items such as rings, bracelets, necklaces, and watches when working with electrical equipment.

B Materials List

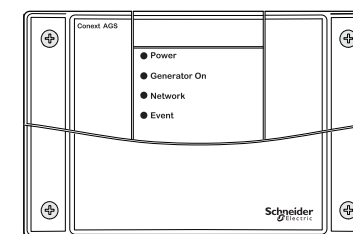

Conext Automatic Generator Start (AGS)

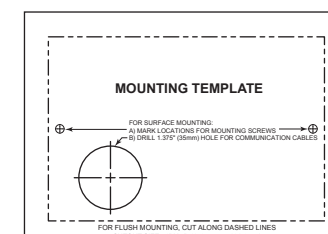

Mounting template sticker

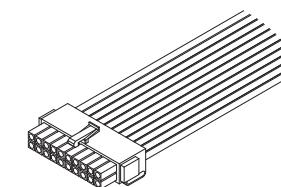

Wiring harness

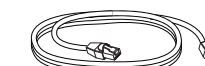

Xanbus cable



4 x #6 (M3) self tapping screws

- Installer Provided Tools and Materials:**
- Phillips head screwdriver
 - Wire cutters and wire strippers
 - Drywall anchors if mounting on drywall
 - #16 or #18 AWG wire (1.31 mm² or 0.283 mm²) depending on generator type
 - Xanbus network terminator if AGS is the last device in network chain
 - 5 Amp inline fuse holders (1 to 3 pieces as required)

A Important Safety Information

Read and Save These Instructions - Do Not Discard

This Guide contains important safety instructions for the Conext Automatic Generator Start that must be followed during installation procedures. Read and keep this Quick Start Guide for future reference.

Read these instructions carefully and look at the equipment to become familiar with the device before trying to install, operate, service or maintain it. The following special messages may appear throughout this bulletin or on the equipment to warn of potential hazards or to call attention to information that clarifies or simplifies a procedure.

The addition of either symbol to a "Danger" or "Warning" safety label indicates that an electrical hazard exists which will result in personal injury if the instructions are not followed.

This is the safety alert symbol. It is used to alert you to potential personal injury hazards. Obey all safety messages that follow this symbol to avoid possible injury or death.

DANGER

DANGER indicates a hazardous situation which, if not avoided, will result in death or serious injury.

WARNING

WARNING indicates a hazardous situation which, if not avoided, could result in death or serious injury.

CAUTION

CAUTION indicates a hazardous situation which, if not avoided, could result in minor or moderate injury.

NOTICE

NOTICE is used to address practices not related to physical injury. The safety alert symbol shall not be used with this signal word.

Contact Information

www.schneider-electric.com

Please contact your local Schneider Electric Sales Representative or visit the Schneider Electric website at:

http://www.SEsolar.com

DANGER

HAZARD OF ELECTRIC SHOCK, EXPLOSION, OR ARC FLASH

- Apply appropriate personal protective equipment (PPE) and follow safe electrical work practices. See NFPA 70E or CSA Z462.
- This equipment must only be installed and serviced by qualified electrical personnel.
- Never operate energized with covers removed
- Energized from multiple sources. Before removing covers identify all sources, de-energize, lock-out, and tag-out and wait 2 minutes for circuits to discharge
- Always use a properly rated voltage sensing device to confirm all circuits are de-energized.

Failure to follow these instructions will result in death or serious injury.

HAZARD OF ELECTRIC SHOCK, EXPLOSION, OR ARC FLASH

Batteries can present a risk of electric shock and high short-circuit current. The following precautions must be observed when working with batteries:

- Remove watches, rings or other metal objects.
- Use tools with insulated handles.
- Wear protective glasses, gloves and boots.
- Do not lay tools or other metal parts on top of batteries.
- Disconnect the charging source prior to connecting or disconnecting battery terminals.

Failure to follow these instructions will result in death or serious injury.

HAZARD OF ELECTRIC SHOCK, EXPLOSION, OR ARC FLASH

- Battery Circuit Breakers must be installed according to the specifications and requirements specified by Schneider Electric.
- Servicing of batteries must only be performed by qualified personnel and the required precautions. Keep unqualified personnel away from batteries.

Failure to follow these instructions will result in death or serious injury.

Exclusion for Documentation

UNLESS SPECIFICALLY AGREED TO IN WRITING, SELLER

- (A) MAKES NO WARRANTY AS TO THE ACCURACY, SUFFICIENCY OR SUITABILITY OF ANY TECHNICAL OR OTHER INFORMATION PROVIDED IN ITS MANUALS OR OTHER DOCUMENTATION;
- (B) ASSUMES NO RESPONSIBILITY OR LIABILITY FOR LOSSES, DAMAGES, COSTS, OR EXPENSES, WHETHER SPECIAL, DIRECT, INDIRECT, CONSEQUENTIAL OR INCIDENTAL, WHICH MIGHT ARISE OUT OF THE USE OF SUCH INFORMATION. THE USE OF ANY SUCH INFORMATION WILL BE ENTIRELY AT THE USER'S RISK, AND
- (C) REMINDS YOU THAT IF THIS MANUAL IS IN ANY LANGUAGE OTHER THAN ENGLISH, ALTHOUGH STEPS HAVE BEEN TAKEN TO MAINTAIN THE ACCURACY OF THE TRANSLATION, THE ACCURACY CANNOT BE GUARANTEED, APPROVED CONTENT IS CONTAINED WITH THE ENGLISH LANGUAGE VERSION WHICH IS POSTED AT WWW.SCHNEIDER-ELECTRIC.COM.

C Installing the Automatic Generator Start – Overview

NOTICE

SHORT CIRCUIT OF NETWORK COMPONENTS

- This network is not an ethernet system. Only connect Xanbus-enabled devices to other Xanbus-enabled devices. Do not attempt to connect Xanbus-enabled devices to other networks or systems.

- Ethernet crossover cables are not compatible with the Xanbus system. Use Category 5 (CAT 5 or CAT 5e) cables to connect Xanbus-enabled devices.

Failure to follow these instructions can result in damage to equipment.

BEFORE MOUNTING: Record the Serial Number found on the back of the unit and keep for your records.

Serial Number: _____

Follow these steps to install the AGS

1. Wall mount the unit.
2. Connect the writing harness to:
 - Generator
 - Thermostats (optional)
 - External shutdown switch (optional)
 - External ON/OFF switch (optional)
3. Connect the wiring harness to the 20-contact connector on the AGS.
4. Connect the AGS to the Xanbus network.

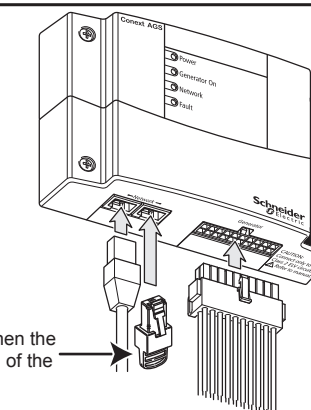

Connect a network terminator when the AGS is the last device at the end of the network

Wall mount the AGS with connectors facing downwards

1. Hold the unit flush and square against the wall, panel, or horizontal surface. If the mounting surface requires pre-drill holes for the screws, use the supplied mounting template to mark, then drill, four holes.
2. Route the Xanbus cable(s) inside the wall and through the opening.
3. With a Phillips screwdriver and the supplied #6 screws (use for plywood only), secure each corner of the AGS to the mounting surface.

D Wiring Harness Wires and Functions

⚠ WARNING

IGNITION AND FIRE HAZARD

- This equipment is not ignition protected. To prevent fire or explosion, do not install this product in locations that require ignition-protected equipment. This includes any confined space containing vented batteries, or flammable chemicals such as, natural gas (NG), liquid petroleum gas (LPG) or gasoline (Benzine/Petrol).
- Do not install in a confined space with machinery powered by flammable chemicals, or storage tanks, fittings, or other connections between components of fuel or flammable chemical systems.
- Do not install near readily flammable materials such as cloth, paper, straw, or plastic sheeting. Keep flammable materials a minimum distance of 600 cm (24 in.) from the top surface and 30 cm (12 in.) from either side surface and the front.

Failure to follow these instructions can result in death or serious injury.

Connections to the generator, thermostats, and external ON/OFF switches are made using a wiring harness that plugs into the 20-contact connector.

The wires on the wiring harness can be extended to meet installation requirements. When extending the wire harness, ensure that the extension wires are the same color as the wires on the harness.

Install the wiring harness

- Connect each wire on the harness to its intended wire or contact on the generator, thermostats, or external switches. Tape, or otherwise secure, the unused wires to ensure they do not make unintended connections.
- Plug the harness into the connector on the bottom panel of the AGS.

Required Wire Size

- 0 to 30 feet (9m): 18 AWG (1.31 mm²)
- Over 30 feet (9m): 16 AWG (0.823 mm²)

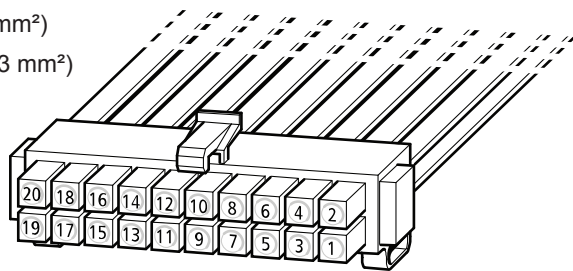

Wire No.	Function	Wiring Harness Wire Color
1	Thermostat 1 input	Yellow
2	Thermostat 1 return	Gray
3	Thermostat 2 input	Orange
4	Thermostat 2 return	Gray
5	External shutdown input	White/Black
6	External shutdown return	Gray
7	External manual on input	White/Green
8	External manual off input	White/Red
9	External ON/OFF LED Indicator output	White/Blue
10	Constant 12/24 V B+ (battery positive) for External ON/OFF/LED Indicator	Red
11	External ON/OFF/LED Indicator return (connected internally to wire number 13)	Black
12	Generator run signal (switched B+) sense input	Violet
13	Generator run signal (switched B+) sense return	Black
14	Relay 1 (Generator run/stop) Normally open contact	Blue
15	Relay 1 (Generator run/stop) Normally closed contact	White/Violet
16	Relay 1 (Generator run/stop) Common contact	Gray
17	Relay 2 (Generator start) Normally open contact	White
18	Relay 2 (Generator start) Common contact	Gray
19	Relay 3 (Preheat/cooldown) Normally open contact	Brown
20	Relay 3 (Preheat/cooldown) Common contact	Gray

E Connecting the Generator

NOTICE

EQUIPMENT DAMAGE

Consult the generator manufacturer to ensure that GenType settings and connections are compatible with your generator. Damage to the generator can result from selecting an incorrect Gen Type and following the connection diagram for an incorrect Gen Type when Connecting the Conext AGS to the generator.

Failure to follow these instructions can result in damage to equipment.

The AGS has 14 preset generator configurations, or Gen Types. After installing the unit, select one of these Gen Types from the AGS **Config** menu on the System Control Panel (SCP).

Important Put the AGS in Standby BEFORE changing the Gen Type. See *G – Configuring the Automatic Generator Start*.

B+ Generator Run Signal

Connecting the B+ Gen Run signal is optional. If the B+ is not connected, it may be necessary to adjust the Gen Run Signal hold time parameter on the AGS.

Type 1

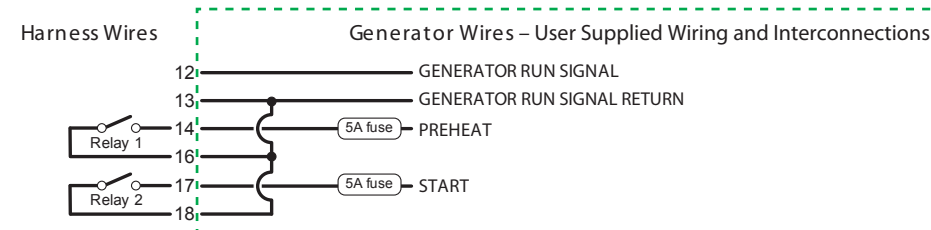

Type 2

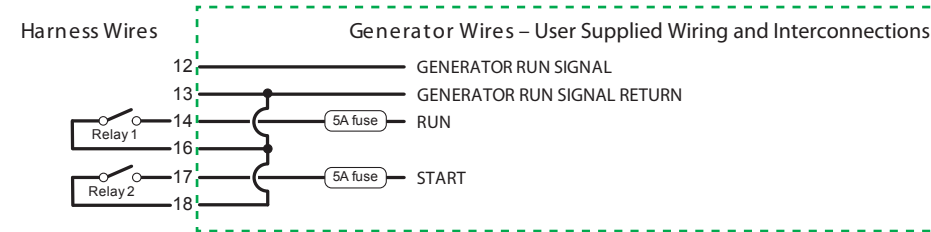

Type 3

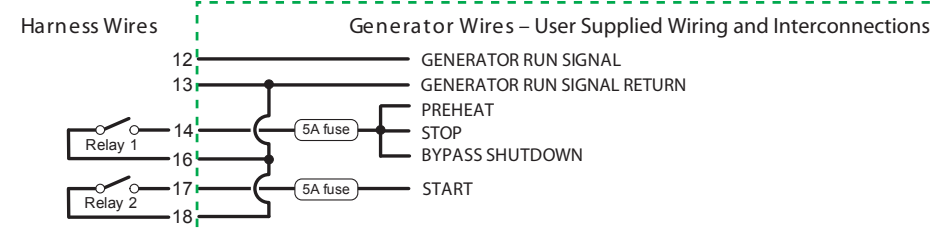

Type 6

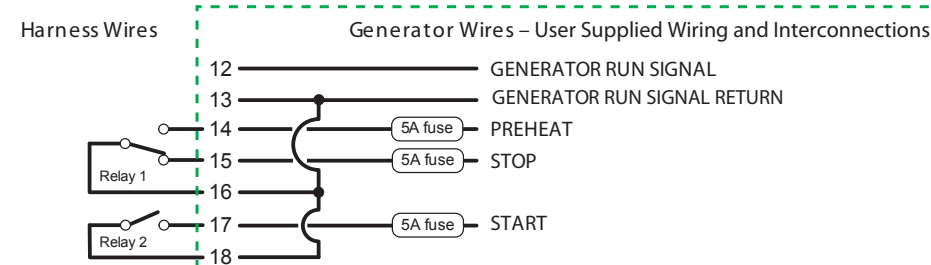

Type 12

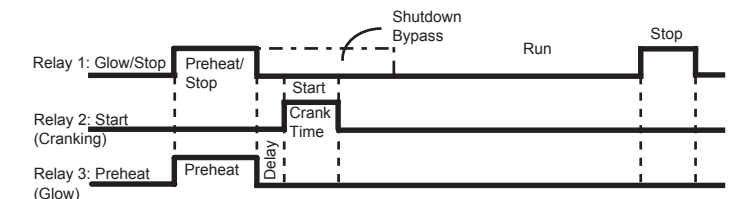
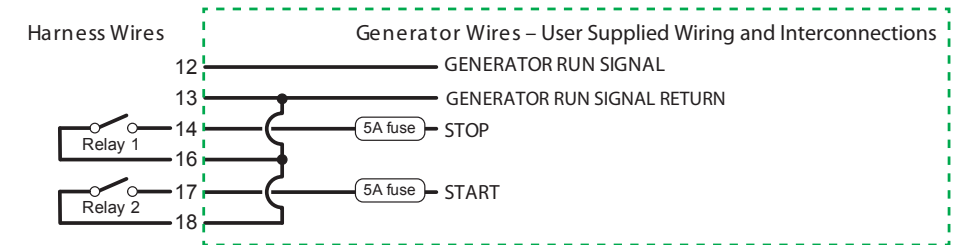

GlowStop Mode Timing Diagrams for Gen Types 1, 2, 3, 6, and 12

Type 4

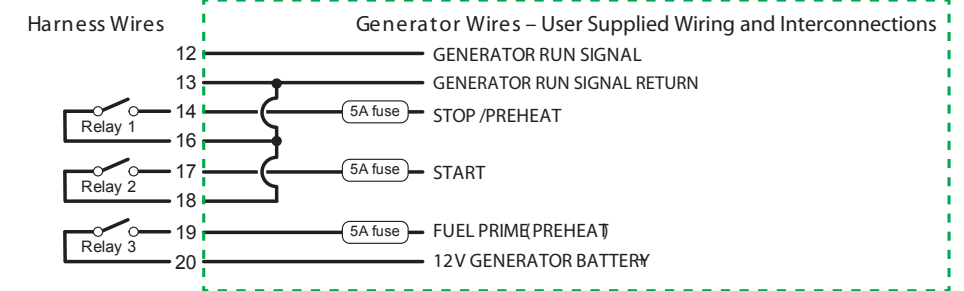

Type 5

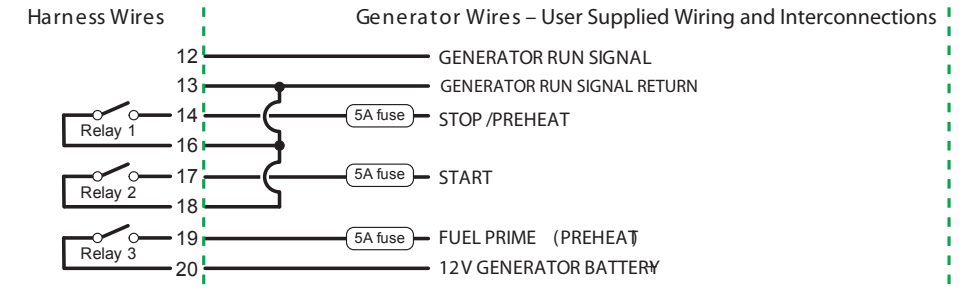

Type 9

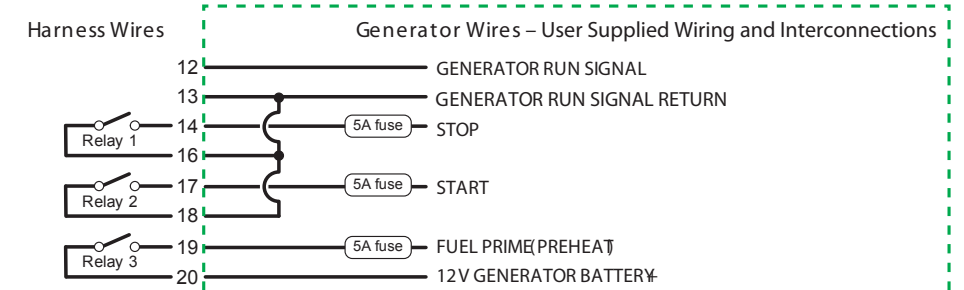

E Connecting the Generator

Type 10

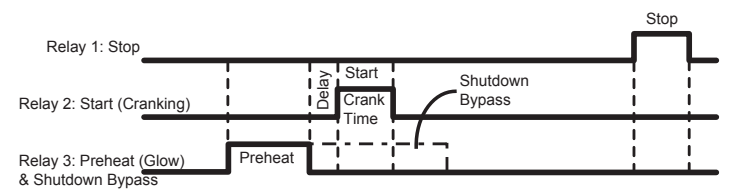
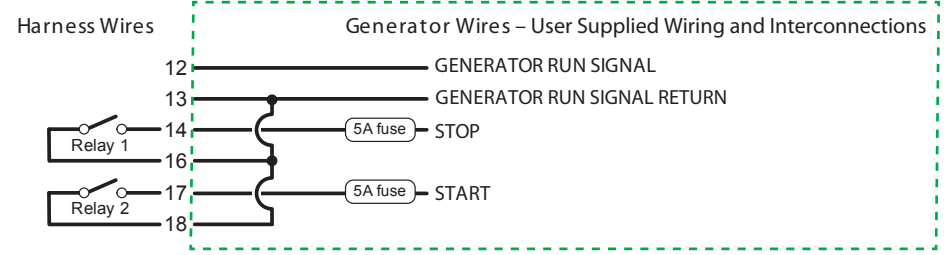

StartStop Mode Timing Diagram for Gen Types 4, 5, 9, and 10

Type 7

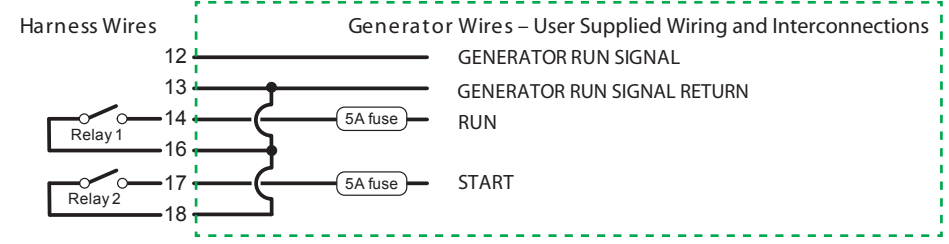
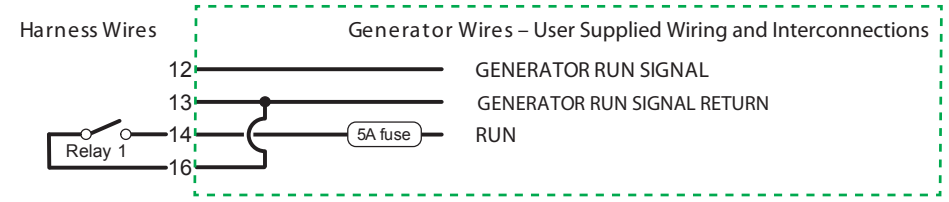

Type 8

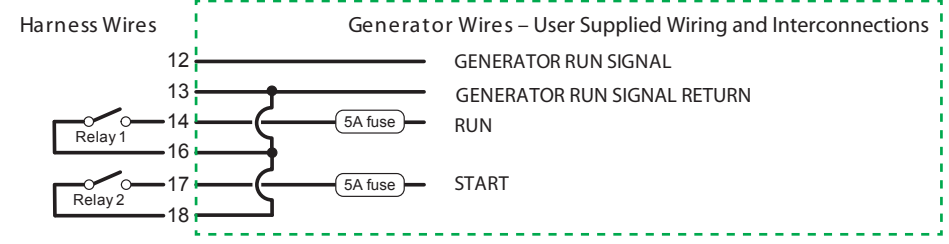
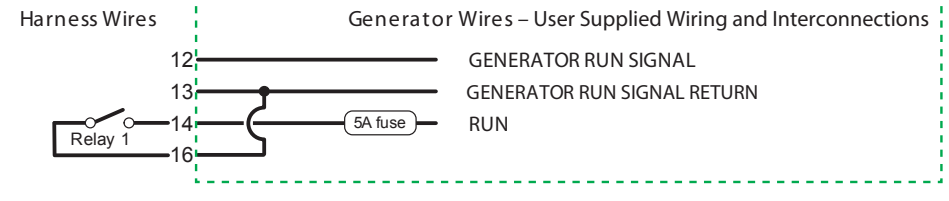

Type 14

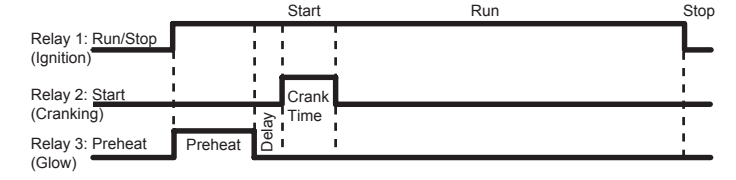
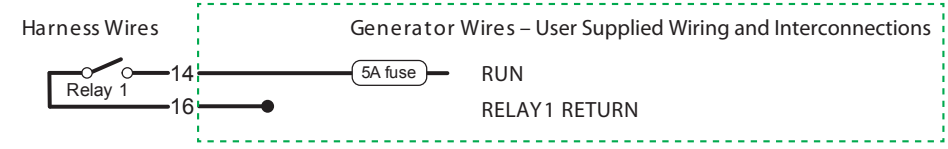

RunMode Timing Diagram for Gen Types 7, 8, and 14

Type 11

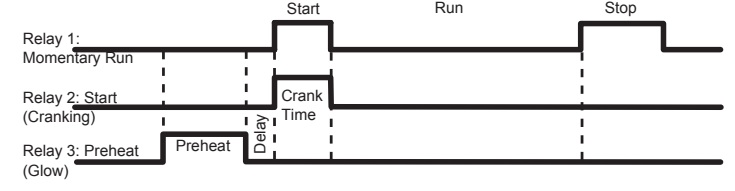
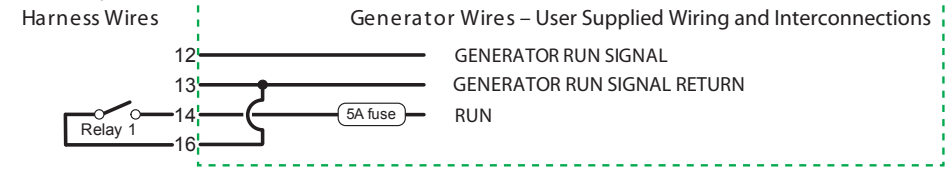

MomentaryRun Mode Timing Diagram for Gen Type 11

Type 13

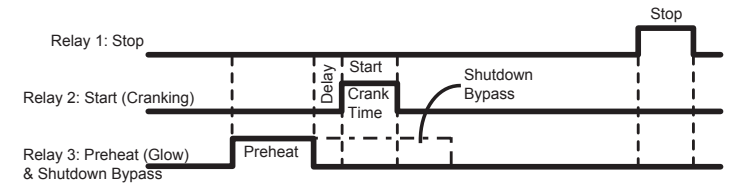
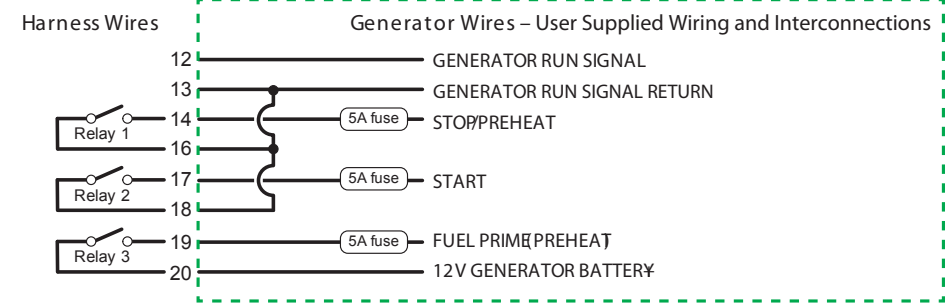

PulseStop Mode Timing Diagram for Gen Type 13

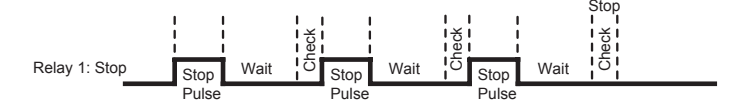

PulseStop Mode Relay 1 Behavior

F Connecting the AGS to the Xanbus Network

NOTICE

SHORT CIRCUIT OF NETWORK COMPONENTS

- This network is not an ethernet system. Only connect Xanbus-enabled devices to other Xanbus-enabled devices. Do not attempt to connect Xanbus-enabled devices to other networks or systems.
- Ethernet crossover cables are not compatible with the Xanbus system. Use Category 5 (CAT 5 or CAT 5e) cables to connect Xanbus-enabled devices.

Failure to follow these instructions can result in damage to equipment.

WARNING

XANBUS SHOCK HAZARD
Xanbus cables in contact with DC or AC power can transmit an electric shock. Do not route the Xanbus cables in the same conduit or panel as the AC and DC power cabling. **Failure to follow these instructions can result in death or serious injury.**

Connect the Xanbus cables

- Insert a Xanbus cable (standard straight-through Ethernet CAT 5e) into one of the network ports on the bottom panel of the AGS.
- Connect the other end of the cable to the next Xanbus-enabled device in the chain. Depending on the layout of the Xanbus network, the following options are available for the other Xanbus port on the AGS:
 - A second network cable to another device in the chain.
 - A network terminator (when the AGS is the last device at one end of the network).

Xanbus Network Layout

The last device on the network must be terminated with a network terminator.

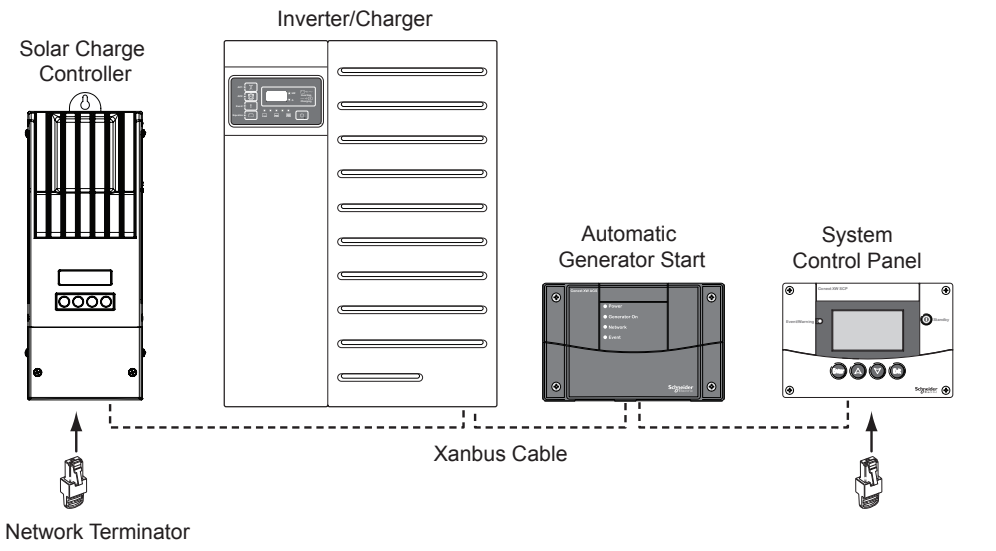

G Configuring the Automatic Generator Start

The AGS is configured using the AGS Setup menu on the Conext System Control Panel (SCP). On the Setup menu, you can change configuration settings, select the generator's operating mode, clear fault warnings and view device information.

For more information on configuring the AGS, see the *Conext Automatic Generator Start Owner's Guide*.

Place the AGS in Standby

Before configuring the AGS, place the unit in Standby using the SCP.

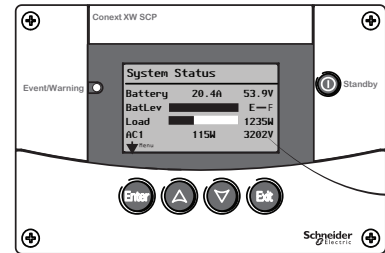

On the System Status screen, press Enter to display the Select Device menu.

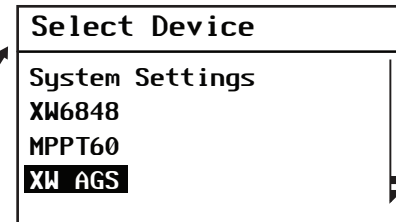

Press down arrow to highlight XW AGS and press Enter.

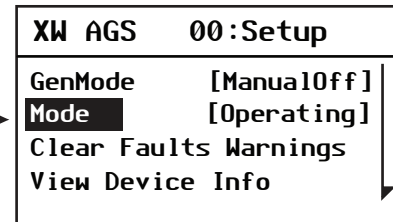

Press down arrow to highlight Mode and press Enter.

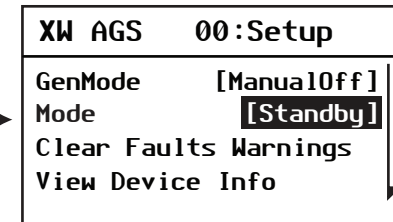

Press down arrow to toggle the setting to Standby and press Enter. Press Exit to go back to the previous screen.

Access AGS configuration settings

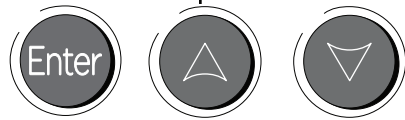
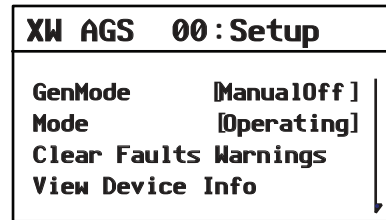

On the AGS Setup menu, press Enter and both up arrow and down arrow keys together briefly to access the Advanced

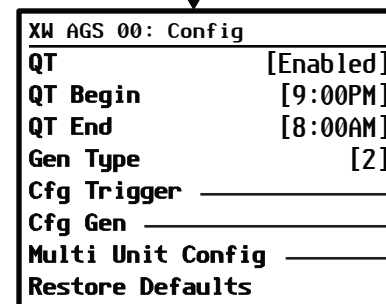
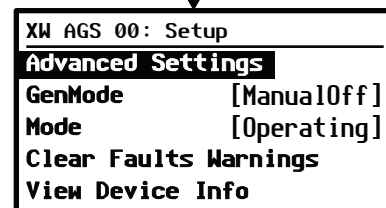

Set the generator type using Gen Type

