

# Conext™ MPPT 80 and MPPT 100 Solar Charge Controller

## Owner's Guide

990-6214

February 2020

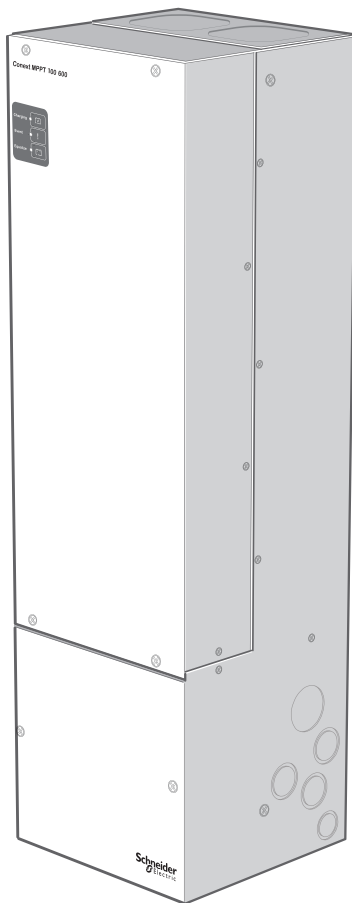

Copyright © 2020 Schneider Electric. All Rights Reserved.

All trademarks are owned by Schneider Electric Industries SAS or its affiliated companies.

### **Exclusion for Documentation**

UNLESS SPECIFICALLY AGREED TO IN WRITING, SELLER

(A) MAKES NO WARRANTY AS TO THE ACCURACY, SUFFICIENCY OR SUITABILITY OF ANY TECHNICAL OR OTHER INFORMATION PROVIDED IN ITS MANUALS OR OTHER DOCUMENTATION;

(B) ASSUMES NO RESPONSIBILITY OR LIABILITY FOR LOSSES, DAMAGES, COSTS OR EXPENSES, WHETHER SPECIAL, DIRECT, INDIRECT, CONSEQUENTIAL OR INCIDENTAL, WHICH MIGHT ARISE OUT OF THE USE OF SUCH INFORMATION. THE USE OF ANY SUCH INFORMATION WILL BE ENTIRELY AT THE USER'S RISK; AND

(C) REMINDS YOU THAT IF THIS MANUAL IS IN ANY LANGUAGE OTHER THAN ENGLISH, ALTHOUGH STEPS HAVE BEEN TAKEN TO MAINTAIN THE ACCURACY OF THE TRANSLATION, THE ACCURACY CANNOT BE GUARANTEED. APPROVED CONTENT IS CONTAINED WITH THE ENGLISH LANGUAGE VERSION WHICH IS POSTED AT <http://solar.schneider-electric.com/>.

**Document Number:** 990-6214

**Date:** February 2020

### **Contact Information**

For country-specific details, please contact your local Schneider Electric Sales Representative or visit the Schneider Electric Solar Business website at: <http://solar.schneider-electric.com/>

### **Information About Your System**

As soon as you open your product, record the following information and be sure to keep your proof of purchase.

Serial Number \_\_\_\_\_

Product Number \_\_\_\_\_

Purchased From \_\_\_\_\_

Purchase Date \_\_\_\_\_

# Audience

This manual is intended for use by qualified personnel installing a system involving Schneider Electric Conext MPPT 80 and Conext MPPT 100 Solar Charge Controller.

The qualified personnel have training, knowledge, and experience in:

- Installing electrical equipment and PV and battery input systems (up to 1000 V).
- Applying all applicable installation codes.
- Analyzing and reducing the hazards involved in performing electrical work.
- Selecting and using Personal Protective Equipment (PPE).

Configuration, servicing, and maintenance must be performed by authorized service personnel only. Authorized service personnel meet the requirements for a qualified installer, plus they have received specific training from the manufacturer on servicing the Conext MPPT 80 or MPPT 100 Solar Charge Controller.

This manual does not contain information regarding servicing or de-energization for servicing. Authorized service personnel must refer to the system schematics to identify, open, lock-out and tag-out, and verify de-energization of all power sources.

Do not use this charge controller unless it has been installed by qualified personnel in accordance with the instructions in the *Conext MPPT 80 and MPPT 100 Solar Charge Controller Installation Guide*.

# About This Guide

## Purpose

This Guide provides explanations and procedures for configuring, operating, and troubleshooting the following Schneider Electric Conext MPPT Solar Charge Controllers:

- Conext MPPT 80 600 Solar Charge Controller (80 A), part number: 865-1032
- Conext MPPT 100 600 Solar Charge Controller (100 A), part number: 865-1034

## Scope

This Guide provides safety guidelines as well as information about operating, configuring, and troubleshooting the charge controller. It does not provide details about particular brands of photovoltaic (PV) panels or batteries.

## Conventions Used

This Guide uses the term “charge controller” to refer to the Conext MPPT 80 and Conext MPPT 100 Solar Charge Controllers.

## Abbreviations and Acronyms

CEC	Canadian Electric Code
CSA	Canadian Standards Association
DC	Direct Current
FCC	Federal Communications Commission
GFP	Ground Fault Protection
$I_{MP}$	Current at maximum power per STC
ISC	Short circuit current rating of an PV panel under STC
LCD	Liquid Crystal Display
LED	Light Emitting Diode
MPP	Maximum Power Point
MPPT	Maximum Power Point Tracking
MSDS	Material Safety Data Sheet
NFPA	National Fire Protection Association
PDP	XW Power Distribution Panel
PV	Photovoltaic
SCP	System Control Panel
STC	Standard Test Conditions specific to photovoltaic panels (1000 W/m <sup>2</sup> , light spectrum AM 1.5 and 25 °C); panel nameplate ratings are based on STC and may be exceeded under other conditions.
UL	Underwriters Laboratories
VAC	Volts AC
VDC	Volts DC
$V_{MP}$	Voltage at maximum power per STC
$V_{OC}$	Open circuit voltage rating of a PV panel under STC

## Related Information

You can find information about installing the charge controller in the *Conext MPPT 80 and Conext MPPT 100 Solar Charge Controller Installation Guide*. It is provided with the charge controller and is also available at [solar.schneider-electric.com](http://solar.schneider-electric.com).

You can find more information about Schneider Electric as well as its products and services at [solar.schneider-electric.com](http://solar.schneider-electric.com).

# Safety Information

## Important Information

Read these instructions carefully and look at the equipment to become familiar with the device before trying to install, operate, service or maintain it. The following special messages may appear throughout this documentation or on the equipment to warn of potential hazards or to call attention to information that clarifies or simplifies a procedure.

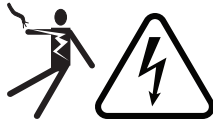

The addition of either symbol to a “Danger” or “Warning” safety label indicates that an electrical hazard exists which will result in personal injury if the instructions are not followed.



This is the safety alert symbol. It is used to alert you to potential personal injury hazards. Obey all safety messages that follow this symbol to avoid possible injury or death.

### **DANGER**

**DANGER** indicates a hazardous situation which, if not avoided, **will result in** death or serious injury.

### **WARNING**

**WARNING** indicates a hazardous situation which, if not avoided, **could result in** death or serious injury.

### **CAUTION**

**CAUTION** indicates a hazardous situation which, if not avoided, **could result in** minor or moderate injury.

### **NOTICE**

**NOTICE** is used to address practices not related to physical injury.

## Please Note

Electrical equipment should be installed, operated, serviced, and maintained only by qualified personnel. No responsibility is assumed by Schneider Electric for any consequences arising out of the use of this material.

A qualified person is one who has skills and knowledge related to the construction, installation, and operation of electrical equipment and has received safety training to recognize and avoid the hazards involved. For more information, see *Audience*.

## Safety Information

- **Before using the charge controller, read all instructions and cautionary markings on the unit, the batteries, and all appropriate sections of this manual.**
- Use of accessories not recommended or sold by the manufacturer may result in a risk of fire, electric shock, or injury to persons.
- The charge controller is designed to be permanently connected to your AC and DC electrical systems. The manufacturer recommends that all wiring be done by a certified technician or electrician to ensure adherence to the local and national electrical codes applicable in your jurisdiction.
- To avoid a risk of fire and electric shock, make sure that existing wiring is in good condition and that wire is not undersized. Do not operate the charge controller with damaged or substandard wiring.
- Do not operate the charge controller if it has been damaged in any way.
- This unit does not have any user-serviceable parts. Do not disassemble the charge controller except where noted for connecting wiring and cabling. See your warranty for instructions on obtaining service. Attempting to service the unit yourself may result in a risk of electrical shock or fire. Internal capacitors remain charged after all power is disconnected.
- To reduce the risk of electrical shock, disconnect both AC and DC power from the inverter before attempting any maintenance or cleaning or working on any components connected to the charge controller. Putting the unit in Standby mode will not reduce this risk.
- The charge controller must be provided with an equipment-grounding conductor.
- Do not expose this unit to rain, snow, or liquids of any type. This product is designed for indoor use only. Damp environments will significantly shorten the life of this product and corrosion caused by dampness will not be covered by the product warranty.
- To reduce the chance of short-circuits, always use insulated tools when installing or working with this equipment. Do not leave tools inside the unit.
- Remove personal metal items such as rings, bracelets, necklaces, and watches when working with electrical equipment.



**DANGER**
**HAZARD OF ELECTRIC SHOCK, EXPLOSION, ARC FLASH, AND FIRE**

- Apply appropriate personal protective equipment (PPE) and follow safe electrical work practices. See NFPA 70E, CSA Z462, or EN 50110-1.
- This equipment must only be installed and serviced by qualified electrical personnel.
- Never operate energized with covers removed
- Energized from multiple sources. Before removing covers identify all sources, de-energize, lock-out, and tag-out and wait 2 minutes for circuits to discharge.
- Always use a properly rated voltage sensing device to confirm all circuits are de-energized.

**Failure to follow these instructions will result in death or serious injury.**

**DANGER**
**HAZARD OF ELECTRIC SHOCK, EXPLOSION, ARC FLASH, AND FIRE**

- Disconnect positive and negative PV conductors before servicing. PV conductors are a shock hazard and must be disconnected before servicing the installation.
- Normally GROUNDED conductors may be UNGROUNDED and ENERGIZED when a GROUND FAULT is indicated on the front panel. Must be serviced by qualified personnel.

**Failure to follow these instructions will result in death or serious injury.**

**WARNING**
**LIMITATIONS ON USE**

Do not use the charge controller with life support equipment or other medical equipment or devices.

**Failure to follow these instructions can result in death, serious injury, or equipment damage.**

**NOTICE****LIGHTNING PROTECTION**

To protect the charge controller's insulation and conductors from damage due to a sudden over-voltage surge such as a lightning strike, install a DC-rated lightning arrester on the PV source circuits.

**Failure to follow these instructions can result in equipment damage.**

## Battery Safety Information



### HAZARD OF ELECTRIC SHOCK, BURN, FIRE, AND EXPLOSION

Batteries contain corrosive electrolyte and can give off explosive gases. Battery circuits present a shock and energy hazard. Observe proper precautions when working with batteries and battery circuits, including:

- Always wear eye protection when working with batteries.
- Wear rubber gloves and boots when handling batteries.
- Remove all jewellery before performing electrical work.
- Install batteries in a well-ventilated area to help prevent the possible buildup of explosive gases.
- Do not dispose of batteries in a fire.
- Do not open or damage the batteries. Exposure to electrolyte is harmful to eyes and skin. It is toxic.
- Do not mix battery types.
- Do not smoke in the vicinity of a battery.
- Use insulated tools when working with batteries.
- When connecting batteries, always verify proper voltage and polarity.
- Do not short-circuit the battery.
- Always use proper lifting techniques when handling batteries.
- Determine if the battery is inadvertently grounded and if so, remove the source from ground. Contact with any part of a grounded battery can result in electrical shock. Remove these grounds during installation and maintenance.
- When using Lithium Ion batteries, ensure that the battery pack being used includes a certified Battery Management System (BMS) with safety protocols.

**Failure to follow these instructions will result in death or serious injury.**

For full installation instructions and safety information, see the documentation provided with the batteries. Consult the MSDS for the batteries for first aid procedures, emergency procedures, and clean-up instructions.

Further details about Lithium Ion support can be found in the document *Lithium Ion Application Note* (document number: 976-0319-01-01, available at [solar.schneider-electric.com](http://solar.schneider-electric.com)).

## FCC Information to the User

This charge controller has been tested and found to comply with the limits for a Class B digital device, pursuant to part 15 of the FCC Rules and Industry Canada ICES-003. These limits are designed to provide reasonable protection against harmful interference when the charge controller is operated in a residential environment. This charge controller generates, uses, and can radiate radio frequency energy and, if not installed and used in accordance with the installation and operation guides, could cause harmful radio frequency interference with radio communications. However, there is no guarantee that interference will not occur in a particular installation. If this charge controller does cause harmful interference with radio or television reception, which can be determined by turning the charge controller off and on, try to correct the interference by one or more of the following measures:

- Reorient or relocate the receiving antenna.
- Increase the separation between the charge controller and the receiver.
- Connect the charge controller to a different circuit from that to which the receiver is connected.
- Consult the dealer or an experienced radio or TV technician for help.

### CAUTION

#### RISK OF INJURY

Unauthorized changes or modifications to the equipment could void the user's authority to operate the equipment.

**Failure to follow these instructions can result in injury or equipment damage.**



# Contents

<b>Audience</b> .....	<b>2</b>
Purpose .....	3
Scope .....	3
Abbreviations and Acronyms .....	4
Related Information .....	5
<b>Safety Information</b> .....	<b>6</b>
Safety Information .....	7
Battery Safety Information .....	9
FCC Information to the User .....	10
<b>Introduction</b> .....	<b>20</b>
Features .....	21
Maximum Power Point Tracking .....	22
Fast Sweep™ Shade Tolerant MPPT Algorithm .....	22
Charge Controlling .....	23
Conext MPPT 80 600 .....	23
Conext MPPT 100 600 .....	23
Configurations .....	23
Battery Temperature Compensation .....	26
Equalization Charging .....	27
Auxiliary Output Functions .....	27
<b>Configuration</b> .....	<b>28</b>
Configuring the Unit .....	29
Conext System Control Panel (SCP) .....	29
Conext Gateway .....	30
Configuring Battery Characteristics and Battery Charging .....	31
Setting a Custom Battery Type .....	33
Battery Temperature Compensation .....	35
Configuring Peak Power Tracking .....	36
Configuring the Auxiliary Output .....	36
Trigger Source Descriptions .....	38
Trigger Source Configurable Ranges .....	39
Configuring Device Settings .....	40
Reducing Tare Loss .....	42
Resetting to Factory Defaults .....	42
<b>Operation</b> .....	<b>43</b>
Viewing Status Information on the Charge Controller .....	44

Viewing Status Information on the Conext System Control Panel or Conext Gateway .....	45
Conext System Control Panel .....	45
Conext Gateway .....	47
Viewing Active Faults, Errors, and Warnings .....	48
Faults .....	49
Errors .....	50
Warnings .....	52
Viewing Fault, Error, and Warning Logs .....	53
Viewing Harvest Logs .....	54
Daily Logs .....	54
Monthly Logs .....	54
Yearly Logs .....	54
Equalizing Batteries .....	55
Remote Power Off (RPO) .....	57
Troubleshooting .....	59
Troubleshooting .....	60
Specifications .....	63
Electrical Specifications .....	64
MPPT Voltage Range .....	65
Operating Below the PV Array Voltage Full Power Range .....	66
Conext MPPT 80 600 .....	66
Conext MPPT 100 600 .....	66
Default Battery Charging Settings .....	67
Mechanical Specifications .....	68
Output Power Versus Ambient Temperature .....	69
Accessories .....	70
Conext System Control Panel .....	70
Conext Gateway .....	70
Conext Config Tool .....	70
Regulatory Approvals .....	71
Conext System Control Panel Menus .....	73
Using the System Control Panel (SCP) .....	74
SCP Menu Map .....	75
Changing Settings Using the SCP .....	76
Viewing the Select Device Menu .....	76
Viewing the Setup Menu .....	76
The Setup Menu .....	77
Configuration Settings .....	78

Monitoring the Unit .....	81
<b>Boost Charging .....</b>	<b>85</b>
Using Boost Charging .....	86





# Figures

Figure 1 PV panel characteristics .....	22
Figure 2 Three-stage Battery Charging Cycle .....	24
Figure 3 Two-stage Battery Charging Cycle .....	26
Figure 4 Battery temperature sensor .....	26
Figure 5 Conext SCP .....	29
Figure 6 Conext Gateway .....	30
Figure 7 Charge controller status LEDs .....	44
Figure 8 Conext Gateway Charge Controller Status screen .....	47
Figure 9 MPPT Operational Window .....	65
Figure 10 Maximum Expected Output Current Versus Input Voltage, Conext MPPT 80 600 .....	66
Figure 11 Maximum Expected Output Current Versus Input Voltage, Conext MPPT 100 600 .....	66
Figure 12 Output power vs. ambient temperature, Conext MPPT 80 600 .....	69
Figure 13 Output power vs. ambient temperature, Conext MPPT 100 600 .....	69
Figure 14 Conext System Control Panel .....	74
Figure 15 Screen and menu descriptions .....	75
Figure 16 Selecting the unit .....	77
Figure 17 Setup menu .....	77
Figure 18 Selecting the configure menu .....	79
Figure 19 Configuration menus (Basic) .....	80
Figure 20 Configuration menus (Advanced) .....	81
Figure 21 Home screen .....	82
Figure 22 Selecting the Meters screen .....	83



# Tables

Table 1 Battery configuration settings .....	31
Table 2 Custom battery settings .....	34
Table 3 Peak power tracking settings .....	36
Table 4 Aux menu settings .....	36
Table 5 Aux menu settings .....	37
Table 6 Trigger source configuration ranges .....	39
Table 7 Device settings .....	40
Table 8 Advanced settings .....	41
Table 9 Tare loss settings SCP with firmware version 1.03 or newer only. ....	42
Table 10 Resetting to factory defaults setting .....	42
Table 11 Charge controller status LEDs .....	44
Table 12 Normal operation information (Meters screen) .....	45
Table 13 Charge stages .....	46
Table 14 Fault messages .....	49
Table 15 Error messages .....	50
Table 16 Warning messages .....	52
Table 17 History menu items .....	53
Table 18 Harvest logs menu items .....	54
Table 19 Charge controller troubleshooting .....	60
Table 20 Electrical specifications .....	64
Table 21 Mechanical specifications .....	68
Table 22 Conext System Control Panel navigation buttons .....	74
Table 23 Setup menu .....	77



# 1 Introduction

## What's in This Chapter?

<b>Features</b> .....	<b>21</b>
<b>Maximum Power Point Tracking</b> .....	<b>22</b>
<b>Fast Sweep™ Shade Tolerant MPPT Algorithm</b> .....	<b>22</b>
<b>Charge Controlling</b> .....	<b>23</b>
Conext MPPT 80 600 .....	23
Conext MPPT 100 600 .....	23
Configurations .....	23
Battery Temperature Compensation .....	26
Equalization Charging .....	27
<b>Auxiliary Output Functions</b> .....	<b>27</b>

## Features

The Conext MPPT 80 and Conext MPPT 100 Solar Charge Controller (charge controller), tracks the maximum power point of a PV array to deliver the maximum available current for optimum charging of batteries. The charge controller can be used with 24 VDC and 48 VDC battery systems only.

The charge controller is designed to regulate the available power from a PV source only. It is not designed to regulate power from other types of power sources.

The charge controller can be installed with a Conext SW Inverter, Conext XW+ or Conext XW Pro Inverter/Charger, or as a stand alone battery charger. For PV rapid shutdown and arc fault detection functions, the charge controller can be installed with the MPPT Disconnect RS. To configure the charge controller, a Conext System Control Panel (SCP) or Conext Gateway (Gateway) is also required (see *Accessories on page 70* for product part numbers). While both the SCP and Conext Gateway provide status information and configuration capabilities, the Conext Gateway provides additional access to configuration settings through a web interface.

Standard features of the charge controller include:

- Two or three-stage charging process, with manual equalization to maximize system performance and maintain expected battery life.
- Maximum Power Point Tracking (MPPT) to deliver the maximum available power from a PV array to a bank of batteries. See *Maximum Power Point Tracking on page 22*.
- Integrated PV Ground Fault Protection (PV GFP).
- Fan-cooled with speed control based on internal (heat sink) temperature.
- 80/100 amp charging current capability (Conext MPPT 80 600/Conext MPPT 100 600).
- Configurable auxiliary output. See *Auxiliary Output Functions on page 27*.
- Three LEDs for displaying operating status (Charging, Equalize, and Event).
- Input over-voltage protection, output over-voltage protection, output under-voltage protection, and output over-current protection. Warnings, errors, and faults are indicated by the red LED. View the associated warning or error message on the SCP or Conext Gateway.
- Xanbus communications network. Xanbus is a network protocol developed by the manufacturer which allows the charge controller to communicate settings and activity to other Xanbus-enabled devices.
- Over-temperature protection and power derating of output power when ambient temperature is high.
- Battery Temperature Sensor (BTS) to provide automatic temperature-compensated voltage setpoints for battery charging. If the BTS is lost or damaged, you can order a replacement from the manufacturer (Part Number 808-0232-02).

## Maximum Power Point Tracking

Maximum Power Point Tracking (MPPT), allows the charge controller to harvest the maximum energy available from the PV array and deliver it to the batteries. The MPPT algorithm continuously adjusts the operating voltage of the array to find the maximum power point. Input power is measured and compared to the amount of input power harvested at the previous operating voltage. The next adjustment to the operating voltage is dependent upon whether the charge controller harvested more or less power than it did at the previous operating voltage.

The algorithm is implemented by applying a variable load on the array—shown by the power curve (solid line) in *Figure 1*—until it finds the peak power (the point at which the combination of the operating voltage and current is maximized), as indicated by **MPP** in *Figure 1*. The charge controller will continue adjusting the operating voltage to stay on the maximum power point. This is necessary as **MPP** changes throughout the day due to panel temperature, panel shading, and sunlight intensity. The adjustments happen without interruption of output power flow to the batteries.

*Figure 1 PV panel characteristics*

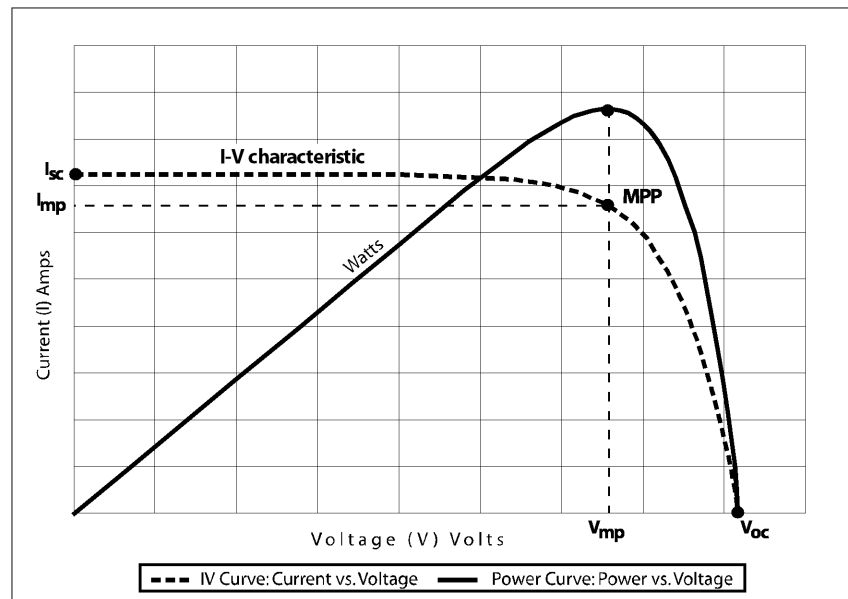

## Fast Sweep™ Shade Tolerant MPPT Algorithm

The charge controller has a Fast Sweep MPPT algorithm that frequently conducts a very fast sweep of the full operational array voltage window to dynamically determine the array's maximum power point. This feature optimizes the high energy harvest of the solar array, regardless of conditions such as temperature and shading. For more information on shade-tolerant MPPT optimization, visit [solar.schneider-electric.com/solar](http://solar.schneider-electric.com/solar).

## Charge Controlling

### Conext MPPT 80 600

The Conext MPPT 80 600 charge controller regulates the PV array current at an appropriate level for 24 or 48 V batteries. It can produce up to 80 amps of charging current for both 2400 watts at 30 V or 4800 watts at 60 V.

### Conext MPPT 100 600

The Conext MPPT 100 600 charge controller regulates the PV array current at an appropriate level for 24 or 48 V batteries. It can produce up to 100 amps of charging current for both 3000 watts at 30 V or 6000 watts at 60 V.

## Configurations

The charge controller can be configured to use a two-stage (no float) or three-stage charging algorithm. The charging algorithm helps to ensure that the battery is optimally charged with the available amount of solar energy.

### Three-Stage Battery Charging

The three-stage battery charging process results in more efficient charging compared to on-off relay type or constant voltage solid-state regulators. The final float stage reduces battery gassing, minimizes electrolyte loss, and ensures complete battery recharging. Battery voltage and current vary during the three-stage charging process, as shown in *Figure 2 on page 24*.

#### Bulk Stage

During the bulk stage, the charge controller operates in constant current mode, delivering the maximum current to the batteries (the maximum current depends on the available solar energy). Once the battery voltage reaches the absorption voltage setting, the charge controller transitions to the absorption stage.

#### Absorption Stage

During the absorption stage, the charge controller operates in constant voltage mode and the charging current falls gradually as the amp hours are returned to the battery. The voltage limit used for the first 60 minutes of this stage is the bulk voltage setting. The voltage limit used for the remaining time in this stage is the absorption voltage setting. The default settings make the bulk voltage setting and the absorption voltage setting the same for all battery types.

The default voltage limit settings (bulk and absorption) can be adjusted if the battery type is set to Custom (see *Configuring Battery Characteristics and Battery Charging on page 31*). For flooded lead acid batteries only, you can use a custom charging scheme which sets the bulk voltage higher than the absorption voltage. The result of this is a boost voltage charge level that has been found to be beneficial for ensuring enough amp hours are returned to the battery bank for off-grid installations. For detailed information on how boost charging works and when it is recommended, see *Using Boost Charging on page 86*.



The charge controller transitions to the float stage if either of the following two conditions are met:

- The charge current into the batteries falls below the exit current threshold, which is equal to 2% of the programmed battery capacity (for a 500 amp-hour battery bank, this would be 10 amps), for one minute.
- The charge controller has been in absorption for the programmed maximum absorption time limit. The default is three hours, but the time limit is programmable from one minute to eight hours.

## Float Stage

During the float stage, the voltage of the battery is held at the float voltage setting. Full current can be provided to the loads connected to the battery during the float stage from the PV array. When battery voltage drops below the recharge voltage setting for one minute, a new bulk cycle is automatically initiated.

*Figure 2 Three-stage Battery Charging Cycle*

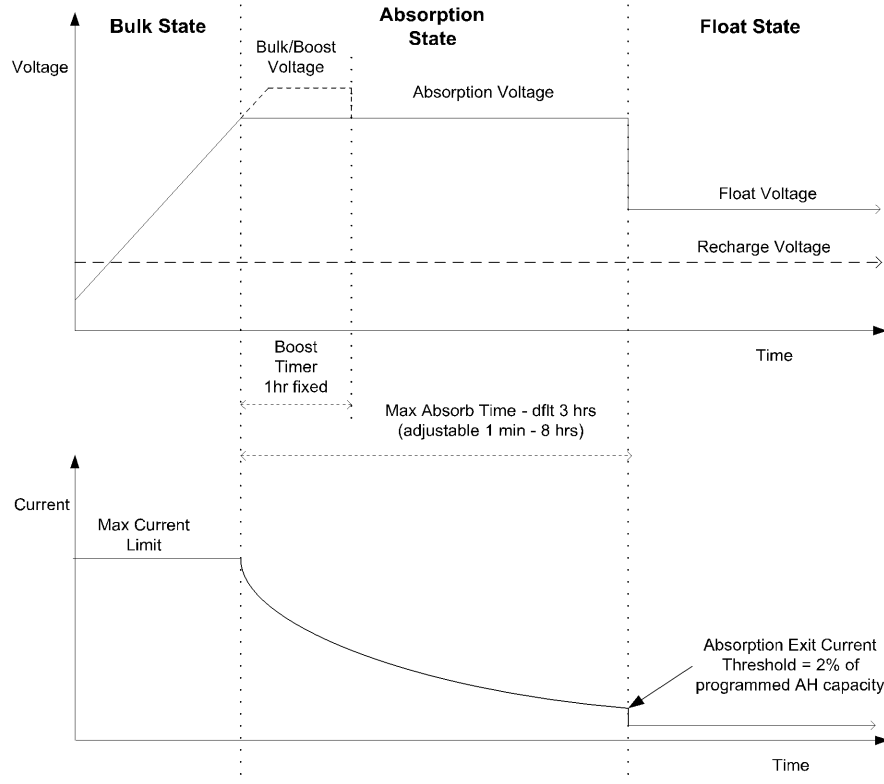

### NOTE:

- When the charge cycle is interrupted, the charge controller will resume charging at the beginning of the multi-stage algorithm.
- The exit current threshold mechanism can be disabled by setting the amp-hour capacity to 0. In this case, absorption will only exit when the absorption timer expires.
- Charge current during the equalize state (an optional state not shown in the figures) is normally limited to a maximum of 10% of the programmed amp-hour capacity setting. If this setting is programmed to 0 Ah, the charge current during equalize is limited to

what is programmed for the maximum current limit of the charge controller (the default is 80 A for Conext MPPT 80 600, and 100 A for Conext MPPT 100 600).

- Synchronized charge states are active when more than one charging device (the charge controller or Conext XW+ or Conext XW Pro Inverter/Charger), is connected in the battery system and a common Xanbus network.
  - The first charging device to enter bulk causes all other Xanbus connected devices to enter bulk.
  - The first charging device to enter absorption causes all other Xanbus connected devices to enter absorption.
  - The last Conext XW+ or Conext XW Pro Inverter/Charger that is ready to exit absorption triggers all Xanbus connected devices to exit absorption and enter float.

## Two-Stage Battery Charging

The two-stage charging process includes the bulk and absorption stages only. There is not a float stage. The relationship between charging current and battery voltage during the two-stage charging process is shown in *Figure 3*.

### No Float State

During the no float state the charge controller does not produce any charge voltage and cannot supply any current. Instead, the charge controller monitors the battery voltage and transitions back to the bulk stage once the voltage drops below the recharge voltage setting for one minute.

**Note:** For more information about battery charging settings, see *Table 1 on page 31, on page 31*.

Figure 3 Two-stage Battery Charging Cycle

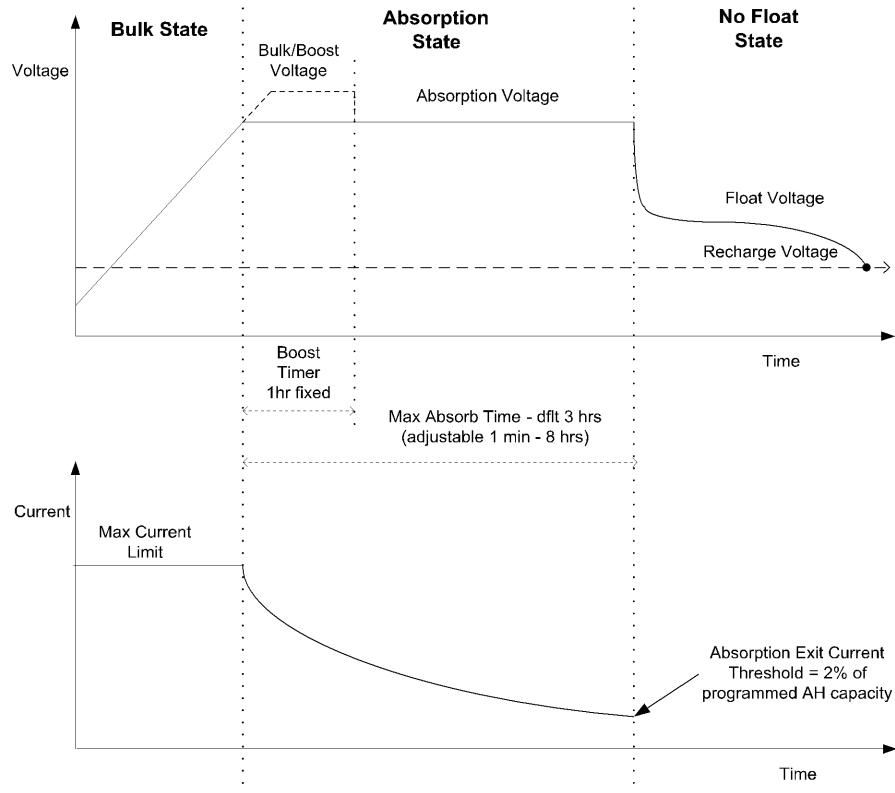

## Battery Temperature Compensation

The Battery Temperature Sensor (BTS) provides temperature-compensation for battery charging. With the BTS installed, the charge controller adjusts the charging voltage as a function of the temperature of the battery to optimize the charging characteristics and help prolong battery life. The BTS also provides over-temperature protection for the batteries.

The BTS plugs into the BTS RJ-11 port located inside the wiring compartment of the charge controller. See “Installing the Battery Temperature Sensor” in the *Conext MPPT 80 and MPPT 100 Solar Charge Controller Installation Guide*.

Figure 4 Battery temperature sensor

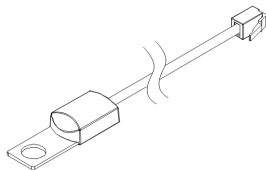

If a BTS is not installed, the voltage settings for charging are based on one of three temperature settings (Cold, Warm, or Hot) available on the Charger Settings menu. See *Configuring Battery Characteristics and Battery Charging on page 31*.

If there are multiple charge controllers and one or more Conext XW+ or Conext XW Pro Inverter/Charger connected to the Xanbus network, then only one BTS is required per battery bank. All networked Xanbus devices share battery temperature information. If there are multiple battery banks and more than one BTS is used within the system, then

the highest reported temperature will be used as the battery temperature for the temperature compensation value of the battery charge algorithm.

## Equalization Charging

The charge controller can provide the battery bank with an equalization charge. Equalization is a deliberate overcharge designed to return each battery cell to optimum condition by reducing sulfation and stratification in the battery. The equalization charge is generally performed only on flooded, vented (non-sealed or "wet") lead-acid batteries, as recommended by the battery manufacturer.

### **NOTICE**

#### **BATTERY DAMAGE**

Read, understand, and follow all cautions and warnings concerning equalization charging. For more information, see *Equalizing Batteries on page 55*.

**Failure to follow these instructions can result in equipment damage.**

## Auxiliary Output Functions

The charge controller has a set of auxiliary relay contacts—one normally opened (NO) and one normally closed (NC)—that can be used to drive a relay for load control or to turn on devices such as vent fans or indicator alarms. The auxiliary output can be configured to trigger under only one condition at a time. See *Configuring Peak Power Tracking on page 36* for information about auxiliary output trigger sources and how to enable and configure the auxiliary output for your application.

### Load Control

The charge controller's auxiliary output can be configured to disconnect or reconnect loads depending on battery voltage. This load control function enables the charge controller to help prevent damage to the battery from over- discharge during periods of poor charging (insufficient sunlight, for example) or excessive loads.

### Vent Fan

The charge controller's auxiliary output can be configured to trigger a small DC fan to clear a battery compartment of harmful gases. To do this the charge controller's auxiliary output is configured to activate when flooded batteries reach their gassing voltage.

### Alarms

The auxiliary output can be configured to trigger an alarm or indicator light when a pre-set condition occurs, such as low or high battery voltage, high PV array voltage, or a charge controller error condition.

## 2 Configuration

### What's in This Chapter?

<b>Configuring the Unit</b> .....	<b>29</b>
Conext System Control Panel (SCP) .....	29
Conext Gateway .....	30
<b>Configuring Battery Characteristics and Battery Charging</b> .....	<b>31</b>
Setting a Custom Battery Type .....	33
Battery Temperature Compensation .....	35
<b>Configuring Peak Power Tracking</b> .....	<b>36</b>
<b>Configuring the Auxiliary Output</b> .....	<b>36</b>
Trigger Source Descriptions .....	38
Trigger Source Configurable Ranges .....	39
<b>Configuring Device Settings</b> .....	<b>40</b>
<b>Reducing Tare Loss</b> .....	<b>42</b>
<b>Resetting to Factory Defaults</b> .....	<b>42</b>

## Configuring the Unit

**WARNING**

**RISK OF FIRE AND ELECTRIC SHOCK**

The Advanced settings for devices other than the SCP are intended for qualified installation/service personnel only. Before changing advanced settings, you must be familiar with the settings and the system-wide impact of changing those settings. Setting parameters incorrectly could damage connected equipment (such as batteries) or could severely affect the performance of your system. Incorrect charging configuration can lead to battery damage and risk of fire. Consult the local utility before enabling sell mode or changing sell mode settings.

**Failure to follow these instructions can result in death, serious injury, or equipment damage.**

The charge controller can be configured using the following devices:

- *Conext System Control Panel (SCP)*
- *Conext Gateway*

### Conext System Control Panel (SCP)

Figure 5 Conext SCP

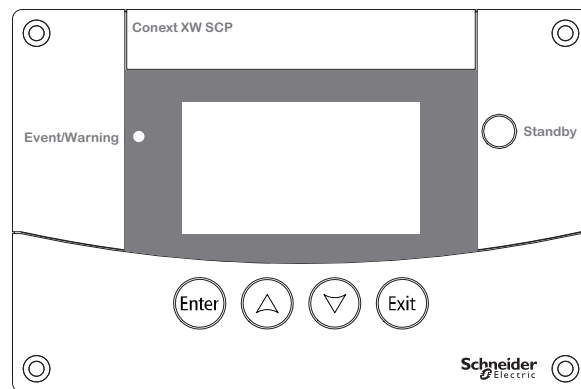

For configuration information, see *Conext System Control Panel Menus on page 73*, or the *SCP Owner's Guide (Document Part Number 975-0298-01-01)*.

See the following sections in the SCP Owner's guide to configure the Conext MPPT 80 or MPPT 100:

- **Putting the charge controller into Standby mode** (see "System Modes" in the SCP Owner's guide)

**Important:** Any configuration (change in settings) made when the Solar Charge Controller is in Operating mode will not be saved unless the charge controller is put into Standby and then back to Operating mode. These modes can be set using the `System Settings` menu in the SCP. Always put the charge controller into Standby

mode prior to changing basic or advanced settings. Then return to Operating mode for the settings to take effect.

- **Viewing basic and advanced settings** (see "Displaying Device Menus" in the SCP Owner's guide). The basic menu contains items you might have to view and adjust on a routine basis. The advanced menu contains items intended for service personnel and one-time setup, such as auxiliary output and custom battery configuration. After configuring the charge controller, help prevent unintended advanced configuration by using the combined keypress (described in the SCP Owner's guide) again to hide the advanced menu items.
- **Modifying configurable settings** (see "Identifying Changeable Settings" in the SCP Owner's guide). Configurable settings are identified by square brackets [ ] around the values along the right side of the screen.

## Conext Gateway

Figure 6 Conext Gateway

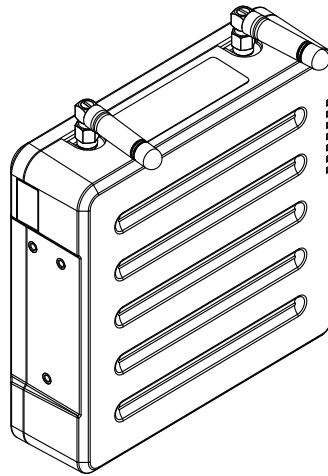

The Conext Gateway allows you to configure and monitor the charge controller using a web application on a PC or laptop. For more information, see the *Conext Gateway Owner's Guide (975-0806-01-xx)*.

See "Changing Device Settings" in the Gateway Owner's guide for the following procedures:

- **Putting the charge controller into Standby mode**

**Important:** Any configuration (change in settings) made when the Solar Charge Controller is in Operating mode will not be saved unless the charge controller is put into Standby and then back to Operating mode.

- **Viewing basic and advanced settings**
- **Modifying configurable settings**

## Configuring Battery Characteristics and Battery Charging

<b>⚠ WARNING</b>
<p><b>HAZARD OF FIRE AND EXPLOSION</b></p> <p>Battery charging settings must be configured by qualified personnel in accordance with the battery manufacturer's recommended charging instructions.</p> <p><b>Failure to follow these instructions can result in death, serious injury, or equipment damage.</b></p>

<b>NOTICE</b>
<p><b>BATTERY DAMAGE</b></p> <p>The charge controller is incapable of determining battery type and cannot warn against or disallow incorrect settings. Carefully check the settings for bulk, absorption, float, and equalization charge against the battery specifications. Incorrect settings can damage the battery or shorten battery life.</p> <p><b>Failure to follow these instructions can result in equipment damage.</b></p>

From various menus in the SCP you can:

- Enable battery equalization.
- Configure your battery type, voltage, and amp-hour capacity.
- Configure a custom battery type by adjusting settings for each battery charge stage and fine-tuning temperature-compensated charging.
- Monitor battery temperature.

Table 1 describes the settings available for the charge controller's battery configuration.

Table 1 Battery configuration settings

SCP Device Menu Item	Setting	Values	Default	Description
Setup	Equalize	Disabled Enabled	Disabled	Enables or disables battery equalization. If the battery type is set to GEL or AGM, this setting is not displayed.
Advanced Settings > Multi Unit Config > Connections	DC Conn	BattBank1...Batt Bankx	BattBank1	Sets the battery bank connected to the charge controller. This is important for networked installations where multiple devices must coordinate their activity around common DC connections.



Advanced Settings > Charger Settings	Batt Voltage	24V 48V	48V	<p>Sets your nominal battery voltage. Select the nominal voltage level that matches your system's battery voltage.</p> <p>Changing the battery voltage will reset <code>Trigger Level</code> and <code>Clear Level</code> to their default values for the auxiliary output if <code>Trig Src</code> is set to <code>LowBattV</code> or <code>HighBattV</code> (see <i>Table 4 on page 36</i>).</p>
Advanced Settings > Charger Settings	Batt Type	Flooded GEL AGM Custom	Flooded	<p>Sets your battery type. Selecting <code>Custom</code> allows you to adjust equalize, bulk, absorption, and float voltage settings (these settings will be referred to 25°C (77°F) battery temperature). You can also adjust battery temperature compensation from the <code>Custom Battery</code> menu. The <code>Custom</code> option is available only when advanced menus are displayed.</p>
Advanced Settings > Charger Settings	Batt Capacity	0–10000Ah	440Ah	<p>Sets the amp-hour capacity of your battery bank.</p> <p>Setting <code>Batt Capacity</code> to 0 disables the exit current threshold mechanism used to transition from absorption to float. As a result, the charge controller will transition to float once the <code>Max Absorption</code> timer has elapsed.</p>
Advanced Settings > Charger Settings	Max Chg Rate	1–100%	100%	<p>Sets the charging current limit as a % of the charge controller's nominal capacity (100A for Conext MPPT 100 600 or 80A for Conext MPPT 80 600).</p>
Advanced Settings > Charger Settings	ReCharge Volts	24V: 20.0–30.0V 48V: 40.0–60.0V	25.0V 50.0V	<p>Sets the voltage at which the charger transitions from float or no float back to bulk or from absorption back to bulk.</p>
Advanced Settings > Charger Settings	Absorb Time	1–480min	180min	<p>Sets the maximum time spent in the absorption stage.</p>
Setup	Force Chg	Bulk Float No Float	Bulk	<p>Manually advances the charge stage to bulk, float, or no float.</p>
Advanced Settings > Charger Settings	Default Batt Temp	Cold Warm Hot	Warm	<p>Sets the default battery temperature for compensation when a BTS is not connected. <code>Cold</code> is suitable for temperatures around 10°C (50°F), <code>Warm</code> for 25°C (77°F), and <code>Hot</code> for 40°C (104°F). Battery charging voltages are set for 25°C (77°F) (<code>Warm</code>) and will be compensated when the battery temperature differs from this value. This screen appears only when a BTS is not connected.</p>
Setup > Meters	Batt Temp	-40–65 C	n/a	<p>Shows the battery temperature (in Celsius) detected by the BTS. This screen appears only when a BTS is connected.</p>

Advanced Settings > Charger Settings	Charge Cycle	3Stage 2StgNoFloat	3Stage	Sets the charging cycle: three- stage (bulk, absorption, float) or two-stage (bulk, absorption, no float).
--------------------------------------	--------------	-----------------------	--------	--

**NOTICE**

**DAMAGE FROM HAVING DIFFERENT CHARGER SETTINGS**

Make sure that all Solar Charge Controller units and all Conext XW+ or Conext XW Pro Inverter/Charger units in a power system setup have the same Charger Settings. For example, if one Solar Charge Controller unit has a Battery Type of Flooded, all Solar Charge Controller units including all Conext XW+ Inverter/Charger units must have the same Battery Type. See **Note** below.

**Failure to follow these instructions can result in equipment damage.**

**Note:** If Cascading is Enabled in SCP, the charger settings will cascade to other Solar Charge Controller devices with the same DC Associations. However they will not cascade to other device types such as Conext XW+, Conext XW Pro, Conext SW, or Conext Battery Monitor even if they have the same DC associations. Make sure that the charger settings are configured correctly on the other device types.

## Setting a Custom Battery Type

**⚠ WARNING**

**HAZARD OF FIRE OR EXPLOSION**

Incorrect settings for specialty batteries, such as lithium ion, can cause dangerous battery over-charging. Always connect the Battery Temperature Sensor (BTS). Custom battery settings should be configured by qualified personnel only.

**Failure to follow these instructions can result in death, serious injury, or equipment damage.**

**NOTICE**

**EQUIPMENT DAMAGE**

To avoid damaging your batteries during charging or equalization, consult your battery manufacturer and associated documentation before setting a custom battery type.

**Failure to follow these instructions can result in equipment damage.**

## **NOTICE**

### **EQUIPMENT DAMAGE**

The charge controller can be configured to produce up to 33.5V (24V system) or 67V (48V system). This voltage may be damaging to some DC equipment. Before setting any voltage greater than 60V for a 48V system or 30V for a 24V system, or before selecting equalize mode, review the specifications for all DC-connected equipment to ensure compatibility with this voltage.

**Failure to follow these instructions can result in equipment damage.**

The *Custom Settings* menu item allows you to adjust charging and equalization voltage for lithium ion and other specialty batteries whose specifications fall outside of the default settings for the battery types that the charge controller offers.

You can also adjust the temperature compensation constant for the BTS from the *Custom Settings* menu item.

### **NOTE:**

- Setting the battery type to Custom is possible only when the Advanced Settings menu item is displayed.
- The Custom Battery menu is displayed only when the battery type is set to Custom.
- All settings for configuring a custom battery type are based on the default settings for a flooded battery type.

The following table describes the available custom battery settings. To access the menu, go to **Advanced Settings > Charger Settings > Custom Settings**. The voltage setpoints are referred to a battery temperature of 25°C (77°F).

*Table 2 Custom battery settings*

<b>Setting</b>	<b>Values</b>	<b>Default</b>	<b>Description</b>
Eqlz Support	Enabled, Disabled	Enabled	Enables or disables equalization for the custom battery.
Setting	Values	Default	Description
Eqlz Voltage	24V: 27.0–33.5V 48V: 54.0–67.0V	32.0V 64.0V	Sets the equalization voltage (consult your battery manufacturer for equalization voltage setting).  This screen is hidden if Eqlz Support is disabled.
Bulk Voltage	24V: 20.0–33.5V 48V: 40.0–67.0V	28.8V 57.6V	Sets the bulk voltage for a custom battery.
Absorb Voltage	24V: 20.0–33.5V 48V: 40.0–67.0V	28.8V 57.6V	Sets the absorption voltage for a custom battery.
Float Voltage	24V: 20.0–33.5V 48V: 40.0–67.0V	27.0V 54.0V	Sets the float voltage for a custom battery.

BattTempComp	24V: -90–0mV/degC	-54mV	Sets the battery temperature compensation for a custom battery. This setting is the reference that the BTS uses to adjust the charging voltage when the temperature falls above or below 25°C. See <i>Charge Controlling on page 23</i> .
	48V: -180–0mV/degC	-108mV/C	

See *Default Battery Charging Settings on page 67* for default settings for standard battery types.

<b>NOTICE</b>
<p><b>EQUIPMENT DAMAGE</b></p> <p>Check the battery specifications carefully before changing the settings for bulk, absorption, float and equalization charging. The charge controller is incapable of determining battery type and cannot warn against or disallow incorrect settings. Incorrect settings may damage the battery or shorten battery life.</p> <p><b>Failure to follow these instructions can result in equipment damage.</b></p>

## Battery Temperature Compensation

When battery charging voltages are compensated based on temperature, the charge voltage will vary depending on the temperature around the batteries. Temperature compensation can be accomplished automatically by using a BTS. The BTS attaches directly to the side of one of the batteries in the bank and provides precise battery temperature information. See “Installing the Battery Temperature Sensor” in the *Conext MPPT 80 and MPPT 100 Solar Charge Controller Installation Guide* for detailed instructions on how and where to install the BTS.

If a BTS is installed, the charge controlling process is automatically adjusted for the battery temperature. The charge controller uses the following coefficients to adjust the charging voltage<sup>1</sup>:

- **Flooded Lead-Acid and Gel-Type Batteries (48 V nominal):**  
-108 mV per degree Celsius
- **Absorbed Glass Mat (AGM)-Type Batteries (48 V nominal):**  
-84 mV per degree Celsius

If using a BTS, when the battery temperature drops below 25°C (77°F), the regulation voltage setting automatically increases. When the temperature rises above 25°C (77°F) the regulation battery voltage setting automatically decreases. The temperature range where compensation is applied is between 0°C and 50°C. Outside of this temperature range, the compensation value is clamped at the corresponding value for either 0°C or 50°C.

If a BTS is not installed, configure the charge controller to use one of three temperature compensated charge settings:

---

<sup>1</sup> For 24 V battery systems, divide these coefficients by two.

- Cold: 10°C (50°F)
- Warm: 25°C (77°F)
- Hot: 40°C (104°F)

If significant seasonal variations are common in your area, change the settings multiple times during the year for optimal battery charging.

## Configuring Peak Power Tracking

You can disable automatic maximum power point tracking and fix the reference voltage level at which the charge controller operates the array. Fixing the array operating reference voltage is not required for normal operation, but it can be useful for testing purposes.

Table 3 Peak power tracking settings

SCP Device Menu Item	Setting	Values	Default	Description
Advanced Settings > Input Settings	MPPT AutoTrack	Disabled Enabled	Enabled	Enables or disables MPPT.
Advanced Settings > Input Settings	MPPT Ref Volts	195–600V	N/A	When tracking is set to <i>Disabled</i> , you can select the reference voltage from which the charge controller operates. When tracking is set to <i>Enabled</i> , the reference voltage updates to reflect tracking activity.
Advanced Settings > Multi Unit Config > Connections	PV In	SolarArray 1–16	SolarArray1	Sets the input connection for the charge controller.

## Configuring the Auxiliary Output

Use the Aux Settings menu item to enable and configure the auxiliary output. You can use the auxiliary output to operate a relay, indicator light, vent fan, alarm, or any other required function. See *Auxiliary Output Functions on page 27*. For configurable trigger sources, you can define trigger level, trigger delay, clear level, and clear delay settings. Non-configurable trigger sources include errors, warnings, and faults.

To display the Aux menu auxiliary settings, select **Advanced Settings > Aux Settings**.

Table 4 Aux menu settings

Setting	Values	Default	Description
Manual Aux	ManualOff ManualOn Automatic	ManualOff	Sets the operating mode for the auxiliary output. When set to <i>Automatic</i> , the auxiliary output will operate according to the selected trigger source. You can toggle the auxiliary relay between NC and NO at any time by selecting <i>ManualOn</i> or <i>ManualOff</i> .

**Note:** The remaining settings in this table are only visible when *Manual Aux* is set to *Automatic*.

Table 5 Aux menu settings

Setting	Values	Default	Description
Trig Src	<p><b>Configurable:</b>                      LowBattV                      HighBattV                      LowArrayV                      HighArrayV                      LowBattTemp                      HighBattTemp                      HighHsTemp</p> <p><b>Not configurable:</b>                      Fault                      GroundFlt1                      GroundFlt2                      InputOVFlt                      InputOVErr                      InputOVWrn                      OutputOVErr                      OutputOVWrn                      OutputOCErr                      BattOTErr                      BattOTWrn                      BattUTWrn                      HsOTErr                      HsOTWrn                      AmbOTErr                      AmbOTWrn                      CapOTErr                      FanErr                      FanFlt                      OutputUVErr                      OutputUVWrn                      InputOCErr                      OutputOCFlt NetPSFlt</p>	LowBattV	<p>Sets the desired condition to activate the auxiliary output. Changing Trig Src while the auxiliary output is already in the triggered state resets the auxiliary output.</p> <p>If Trig Src is set to LowBattV or HighBattV, then changing battery voltage (see Table 1 on page 31) will reset Trigger Level and Clear Level to their default values.</p> <p>For a description of the non-configurable faults, errors, and warnings that you can set for Trig Src, see <i>Viewing Active Faults, Errors, and Warnings</i> on page 48.</p>
Trigger Level	Depends on Trigger Source (see on page 36)		<p>Sets the battery or array voltage to activate the auxiliary output. If the selected trigger source is HighBattTemp, LowBattTemp, or HighHsTemp, this screen displays Trigger Temperature Level in degrees Celsius. Changing Trigger Level while the auxiliary output is already in the triggered state resets the auxiliary output.</p> <p>This setting is hidden if the trigger source is set to an error, warning, or fault.</p>

Trigger Delay	0–600s	1s	<p>Sets how long—in seconds—the selected trigger source must be active before the auxiliary output activates. This can avoid unnecessary triggering by momentary loads.</p> <p>This setting is hidden if the trigger source is set to an error, warning, or fault.</p>
Clear Level	Depends on Trigger Source (see on page 36)		<p>Sets the battery or array voltage to turn off the auxiliary output. If the selected trigger source is HighBattTemp, LowBattTemp, or HighHsTemp, this screen displays Clear Temperature Level in degrees Celsius.</p> <p>This setting is hidden if the trigger source is set to an error, warning, or fault.</p>
Clear Delay	0–600s	1s	<p>Sets how long—in seconds—the trigger condition must remain inactive before the auxiliary output turns off.</p> <p>This setting is hidden if the trigger source is set to an error, warning, or fault.</p>

**Note:** If the selected trigger source is LowBattV or HighBattV, changing the Batt Voltage setting will reset the Trigger Level and Clear Level settings to their default values.

## Trigger Source Descriptions

Configurable trigger sources are described below. The text in parentheses indicates how the trigger source appears on the SCP. The remaining trigger sources are errors, warnings, and faults that are not configurable. See their descriptions in *Warning messages on page 52*.

**Low battery voltage** (LowBattV): Activates the auxiliary output when the battery voltage falls below the trigger setting for the trigger delay time. Deactivates the auxiliary output when the battery voltage rises above the clear setting for the clear delay time. Use this setting if you want the auxiliary output to control a relay to disconnect loads from a battery that is nearly discharged, or to activate a low-battery-voltage alarm such as a buzzer or light.

**High battery voltage** (HighBattV): Activates the auxiliary output when the battery voltage rises above the trigger setting for the trigger delay time.

Deactivates the auxiliary output when the battery voltage falls below the clear setting for the clear delay time. This setting is useful for:

- Installations that have another external charging source such as a wind generator or hydro generator connected directly to the batteries. The charge controller's auxiliary output can control a relay to disconnect the external charging source from the battery when the battery is close to being overcharged or control a relay to turn on a diversion load.
- Activating a high-battery-voltage alarm such as a buzzer or light.

- Activating a vent fan to disperse hydrogen from the battery compartment when the batteries reach their gassing voltage.

**Low array voltage** (*LowArrayV*): Activates the auxiliary output when the PV array voltage falls below the trigger setting for the trigger delay time. Deactivates the auxiliary output when the PV array voltage rises above the clear setting for the clear delay time.

**High array voltage** (*HighArrayV*): Activates the auxiliary output when the PV array voltage rises above the trigger setting for the trigger delay time. Deactivates the auxiliary output when the PV array voltage falls below the clear setting for the clear delay time. Use this setting if you want the auxiliary output to control a series latching relay to disconnect the PV array from the charge controller or trigger an alarm when the PV array voltage exceeds the trigger setting (the charge controller's maximum operating voltage is 550 VDC).

**Low battery temperature** (*LowBattTemp*): Activates the auxiliary output when the battery temperature falls below the trigger setting for the trigger delay time. Deactivates the auxiliary output when the battery temperature rises above the clear setting for the clear delay time. Battery temperature is measured with a BTS. Do not use this setting if a BTS is not installed. With this setting, the auxiliary output can turn on an indicator alarm if the batteries are too cold. A battery with frozen electrolyte will not accept a charge.

**High battery temperature** (*HighBattTemp*): Activates the auxiliary output when the battery temperature rises above the trigger setting for the trigger delay time. Deactivates the auxiliary output when the battery temperature falls below the clear setting for the clear delay time. Battery temperature is measured with a BTS. Do not use this setting if a BTS is not installed. With this setting, the auxiliary output can turn on a fan to cool the battery compartment.

**High heat sink temperature** (*HighHsTemp*): Activates the auxiliary output when the charge controller's heat sink temperature rises above the trigger setting for the trigger delay time. Deactivates the auxiliary output when the heat sink temperature falls below the clear setting for the clear delay time. This setting can be used to trigger an alarm.

**Fault** (*Fault*): Activates the auxiliary output when any error, warning, or fault occurs. This trigger source is not configurable.

## Trigger Source Configurable Ranges

This table contains the available configuration ranges and default settings for configurable trigger sources. The units vary according to the trigger source selected. If the selected trigger source is based on a battery voltage, the range also varies according to the nominal battery voltage of your system.

**Note:** Changing the trigger level resets the auxiliary output. If an auxiliary output trigger is active, changing the trigger level will clear the trigger.

Table 6 Trigger source configuration ranges

Trigger Source	Range	Default Trigger	Default Clear
Low battery voltage ( <i>LowBattV</i> )	24V: 18–26V	22V	24V
	48V: 36–52V	44V	48V



High battery voltage (HighBattV)	24V: 24–34V	28V	26V
	48V: 48–68V	56V	52V
Low array voltage (LowArrayV)	10–600V	190V	195V
High array voltage (HighArrayV)	190–600V	575V	500V
Low battery temperature (LowBattTemp)	-20.0–10.0°C	-10.0°C	-5.0°C
High battery temperature (HighBattTemp)	30.0–60.0°C	45.0°C	40.0°C
High heat sink temperature (HighHsTemp)	-20–95°C	90°C	85°C

## Configuring Device Settings

From various menus, you can change the operating mode of the charge controller and view the charge controller's device number. These activities might be necessary when performing service or diagnostics as well as when adding another Xanbus-enabled device to the system.

**NOTICE**

**EQUIPMENT DAMAGE**

Any configuration (change in settings) made when the Solar Charge Controller is in Operating mode will not be saved unless the MPPT is put in Standby and then back to Operating mode. It is recommended to put the MPPT in Standby mode prior to changing basic or advanced settings. Then return to Operating mode for the settings to take effect.

**Failure to follow these instructions can result in equipment damage.**

Table 7 Device settings

SCP Menu Item	Setting	Values	Default	Description
Setup	Mode	Operating Standby	Operating	Operating is the normal mode for the charge controller. Standby disables the charge controller so that it cannot charge. The charge controller still draws some power from the battery to operate.
Advanced Settings > Multi Unit Config	Dev Number	00 to 31	00	Displays the device number for the charge controller. This number is set when the charge controller is commissioned and uniquely identifies devices of the same type (charge controllers, inverterchargers, control panels, and so on) in a networked installation.
Select Device > System Settings > View Device Info	F/W Rev. 1.00.00 BN 5	N/A	N/A	Firmware version and firmware build number.

 <b style="font-size: 1.2em;">WARNING</b>
<p><b>HAZARD OF FIRE AND EXPLOSION</b></p> <p>Do not use the <code>Copy from</code> command to copy settings unless the battery banks are identical – the same size, type, and so on.</p> <p><b>Failure to follow these instructions can result in death, serious injury, or equipment damage.</b></p>

Table 8 Advanced settings

SCP Menu Item	Setting	Values	Default	Description
Advanced Settings	Copy from	All other similar Xanbus connected devices	01	<p>Enables one-step configuration of a new charge controller in a multi-unit installation. Select the device number of the charge controller from which you want to copy the setup. This screen is hidden when no compatible devices are found.</p> <p>The <code>Copy from</code> command copies all charger settings and custom battery settings from the selected charge controller.</p>

**Note:**

The `Copy from` command will not give you any indication that it has completed its task. To check that the charger settings have been copied properly, view some of the settings you originally configured.

Settings that are copied from one charge controller to another are:

- Batt Type
- Batt Capacity
- Max Chg Rate
- Charge Cycle
- ReCharge Volts
- Absorb Time
- Default Batt Temp
- Batt Voltage
- DC Conn
- Custom battery settings (if Custom battery type selected) including `Eqlz Support`, `Eqlz Voltage`, `Bulk Voltage`, `Absorb Voltage`, `Float Voltage`, and `BattTempComp`.

## Reducing Tare Loss

To reduce power consumption at night, you can configure the charge controller to shut off the Xanbus network power supply. You can change these settings using the *Adv Features* menu item in the SCP.

To display the tare loss settings, select **Advanced Settings > Adv Features**.

Table 9 Tare loss settings<sup>1</sup>

Setting	Values	Default	Description
NetPS Night Dis	Enabled Disabled	Disabled	Enables or disables the Xanbus network power supply nighttime disconnect. If your system does not require network communication at night, then set it to <i>Enabled</i> to turn off the power supply automatically two hours after sunset, and then turn on again at sunrise. If your system requires network communication at night, then leave it set to <i>Disabled</i> .
Lo Pwr at Night	Enabled Disabled	Enabled	Enables or disables the auxiliary power supply nighttime disconnect. Leaving the setting as <i>Enabled</i> reduces tare losses during the night. In this case, if the PV voltage falls below 195V for 2 minutes (at night, or if the PV disconnect is opened) the charge controller will go to sleep and will not send updates over Xanbus. This gives the appearance that the unit is unresponsive. The unit will wake briefly every 2 minutes to check the PV voltage and, if above 230V, will start charging. If faster response is desired (eg. for configuring or troubleshooting) this feature may be disabled.

## Resetting to Factory Defaults

From the *Advanced Settings* menu item, you can restore factory default settings.

Table 10 Resetting to factory defaults setting

Setting	Values	Default	Description
Restore Defaults	N/A	N/A	Returns configurable settings to factory defaults. You will be prompted with a warning asking you to confirm that you want to restore defaults. Press <i>Enter</i> to continue.

The following are reset:

- Configurable battery/charger settings
- Configurable auxiliary output settings
- Configurable input settings

<sup>1</sup>SCP with firmware version 1.03 or newer only.

## 3 Operation

### What's in This Chapter?

<b>Viewing Status Information on the Charge Controller</b> .....	<b>44</b>
<b>Viewing Status Information on the Conext System Control Panel or Conext Gateway</b> .....	<b>45</b>
Conext System Control Panel .....	45
Conext Gateway .....	47
<b>Viewing Active Faults, Errors, and Warnings</b> .....	<b>48</b>
Faults .....	49
Errors .....	50
Warnings .....	52
<b>Viewing Fault, Error, and Warning Logs</b> .....	<b>53</b>
<b>Viewing Harvest Logs</b> .....	<b>54</b>
Daily Logs .....	54
Monthly Logs .....	54
Yearly Logs .....	54
<b>Equalizing Batteries</b> .....	<b>55</b>
<b>Remote Power Off (RPO)</b> .....	<b>57</b>

## Viewing Status Information on the Charge Controller

The charge controller has three LEDs for displaying basic operating information. They are Charging (green), Event (red), and Equalize (orange).

Figure 7 Charge controller status LEDs

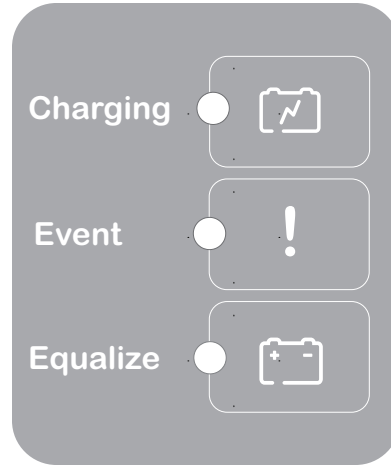

Table 11 Charge controller status LEDs

LED	Description
Charging (Green)	<p>Solid when the charge controller is connected to a battery, providing visual feedback that the charge controller is powered on.</p> <p>Flashing at a variable rate when the charge controller is charging a battery. Slow flashing indicates a low charge rate, and fast flashing indicates a faster charge rate.</p>
Event (Red)	<p>Solid when the charge controller has detected an error or fault condition.</p> <p>Flashing at a constant rate when the charge controller has detected a warning condition.</p> <p>View the error, fault, or warning and its description on the SCP.</p>
Equalize (Orange)	<ul style="list-style-type: none"> <li>■ Solid when an equalize charge has been enabled via the SCP but has not yet started (the charge controller must complete a full bulk and absorption cycle before it can begin the equalize cycle).</li> <li>■ Flashing at a constant rate when the charge controller is performing the equalize charge to the batteries. After the equalize charge has completed, the LED goes dark.</li> </ul>

# Viewing Status Information on the Conext System Control Panel or Conext Gateway

## Conext System Control Panel

Use the Conext System Control Panel (SCP) to configure, view system information and operating status. See *Conext System Control Panel Menus on page 73* for an overview of the SCP, or see the *SCP Owner's Guide (Document Part Number 975-0298-01-01)*.

- When in Charge Control mode the SCP displays parameters such as PV voltage, battery voltage, and charge current on the *XW MPPT80* or *XW MPPT100* Home screen.
- When a fault or error condition exists, the SCP Fault/Warning light is solid, and the SCP shows `Fault Active` on the *XW MPPT80* or *XW MPPT100* Home screen.
- When a warning condition exists, the SCP Fault/Warning light is flashing, and the SCP shows `Warning Active` on the *XW MPPT80* or *XW MPPT100* Home screen.

## Normal Operation

From the *XW MPPT80 Setup* or *XW MPPT100 Setup* screen, select `Meters` to view normal operation information. This information is refreshed once per second.

Table 12 Normal operation information (Meters screen)

Display	Description
PV In Power	Measured input power.
PV In	Measured input voltage and current.
DC Out Power	Power being produced by the charge controller now.
DC Out	Measured output voltage and output current.
Time in Float 00:00:00	Elapsed time that the charge controller has been in float in hh:mm:ss format.
Today	Accumulated amp hours and kilowatt hours produced today by the charge controller.
Life	Lifetime accumulated amp hours and kilowatt hours produced by the charge controller.
Batt Temp	Battery temperature detected by the BTS. If a BTS is not connected, then no value is shown.
Display	Description
State	Charge stage. See <i>Table 13</i>
Aux	Auxiliary output state. See <i>Table 4 on page 36</i>
Thermal Derating	Indicates whether the charge controller is derating output power due to high operating temperatures. See <i>Figure 12 on page 69</i>

## Charge Stages

The charge stages displayed on the SCP are described in *Table 13*. The charge states are displayed under *State* on the *Meters* screen.

*Table 13 Charge stages*

Text	Description
Bulk	<p>Batteries are charging at the maximum current available from the charge controller.</p> <p>If the charge controller shuts down because of low input PV voltage, then charging will resume in bulk mode. This means the charge controller starts in bulk at the beginning of every day, regardless of the battery voltage. If the batteries are fully charged, the bulk/ absorption cycle finishes after a short period and the charge controller transitions to float/ no float (depending on charge cycle configuration).</p>
Absorb	<p>After transitioning from bulk mode, the charge controller holds the battery voltage at the absorption voltage setting and the charge current gradually declines as the battery is charged. The charge controller stops absorption charging when one of two conditions are met, as described in <i>Absorption Stage on page 23</i></p>
Float	<p>Battery voltage is held at the float voltage setting. When the battery voltage drops below the <i>ReCharge Volts</i> setting for a cumulative period of one minute, a new bulk charge cycle is triggered.</p>
No Float	<p>The charge controller does not output any power during this stage. When the battery voltage drops below the <i>ReCharge Volts</i> setting for a cumulative period of one minute, a new bulk cycle is triggered.</p>
Equalize	<p>A deliberate overcharge designed to return each battery cell to optimum condition by reducing sulfation and stratification in the battery. An equalization charge lasts one hour.</p>
Not Charging	<p>No charging is occurring because the input power from the PV array has fallen below the minimum PV array operating voltage (as specified in <i>Electrical Specifications on page 64</i>).</p>

## Conext Gateway

The Conext Gateway allows you to configure, view system information and operating status of the charge controller using a web application on a PC or laptop. For more information, see the *Conext MPPT 80 and MPPT 100 Owner's Guide*.

### To view status information:

1. Log in to the Conext Gateway web application.
2. Go to **Devices > Charge Controller**, and then select your charge controller.
3. Verify that the **Status** tab is selected.

Figure 8 Conext Gateway Charge Controller Status screen

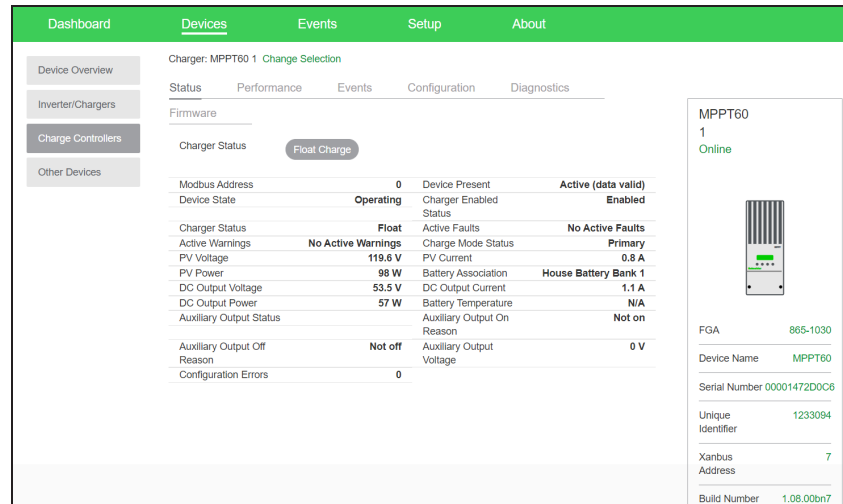

**Note:** This image is for illustrative purposes only.



## Viewing Active Faults, Errors, and Warnings

When a fault, error, or warning occurs, a message is displayed on the SCP or Conext Gateway. You can also view active faults, errors, and warnings from the *System Settings* menu.

Warning messages indicate a problem that could affect normal operation. The charge controller's red LED flashes when there is a warning condition. The SCP Fault/Warning light flashes red, and the warning message is displayed on the SCP. Normal operation continues until the warning escalates to a fault or error condition.

Fault messages indicate a fault or error condition. The charge controller's red LED is solid when there is a fault or error condition. The SCP Fault/Warning light is solid red, and the fault message is displayed on the SCP. When a fault or error occurs, MPPT and charging functions could be disabled.

The following faults do not disable normal operation:

- Fan over voltage
- Fan over current
- Fan under voltage
- Fan under current
- Network power supply

Most warnings, errors, and faults clear automatically once the condition that caused them goes away. However, the following faults must be cleared manually:

- Auxiliary power supply
- Ground fault protection
- Input over voltage
- Output over current
- Fan over voltage
- Fan over current
- Fan under voltage
- Fan under current
- Network power supply

To view the complete list of active faults, errors, and warnings:

1. On the *Select Device* menu, scroll to *System Settings*, and then press **Enter**.  
*The System Settings menu opens.*
2. Scroll to *View Fault List* or *View Warning List*, and then press **Enter**.<sup>1</sup>  
*The fault/error or warning menu opens.*

---

<sup>1</sup> Additional steps are required for a ground fault. See "GroundFlt1" in *Fault messages*.

- Press the down button to view additional fault, error, or warning messages. If there are no active faults, errors, or warnings, no messages are displayed.

## Faults

The following table lists all possible faults. Faults are conditions that indicate that the charge controller might have incurred permanent damage or that user intervention is required before the charge controller will operate again. If one of these faults occur, the charge controller might also need to be serviced before it can be fully operational again.

Table 14 Fault messages

Display Text (Description)	Fault ID	Definition
AuxPSFlt (Auxiliary power supply fault)	F54	More than two auxiliary power supply errors (F26) have occurred within one minute. Damage to the charge controller is possible, so the fault will not clear until an operator clears it manually using the SCP.
GroundFlt1 (Ground fault, type 1)	F56	A PV ground fault has been detected. The ground fault message clears after system power is removed, the ground fault is corrected, the GFP fuse is replaced by qualified personnel (negative or positive grounded systems only), and system power is restored. See the <i>Conext MPPT 80 and Conext MPPT 100 Solar Charge Controller Installation Guide</i> for more information.
InputOVFlt (Input over voltage fault)	F74	Input voltage has exceeded 600 VDC. Damage to the charge controller is possible, so the fault will not clear until an operator clears it manually using the SCP.
FanOVFlt (Fan over voltage fault)	F75	Fan voltage has risen above 13.8 V. The fan will cease operating, but the charge controller will continue operating though it will probably experience power derating. The fault will not clear until an operator clears it manually using the SCP.
OutputOCFlt (Output over current fault)	F78	Three output over current errors (F71 or F73) have occurred within 60 seconds. The fault will not clear until an operator clears it manually using the SCP.
FanOCFlt (Fan over current fault)	F79	More than two Fan Errors have occurred within 30 seconds. The fan will cease operating, but the charge controller will continue operating though it will probably experience power derating. The fault will clear itself when the operator toggles power to the charge controller.
FanUVFlt (Fan under voltage fault)	F80	Fan voltage has fallen below 3.5 V. The fan will cease operating, but the charge controller will continue operating though it will probably experience power derating. The fault will not clear until an operator clears it manually using the SCP.
FanUCFlt (Fan under current fault)	F81	Fan current has fallen below 0.5 A for 100 milliseconds. The fan will cease operating, but the charge controller will continue operating though it will probably experience power derating. The fault will not clear until an operator clears it manually using the SCP.

<p>NetPSFlt (Network power supply fault)</p>	<p>F82</p>	<p>A short circuit or an overload condition has been detected on the Xanbus network power supply. An over voltage event has been detected on the Xanbus network power supply. The network power supply will be turned off, and loss of network communication is possible. The fault will not clear until an operator clears it manually. The operator might have to power cycle the charge controller if no other devices are present on the Xanbus network to provide network power to run the SCP.</p>
<p>GroundFlt2 (Ground fault, type 2)</p>	<p>F84</p>	<p>A problem exists with the hardware circuitry used to detect ground faults. Contact customer service for assistance.</p>

## Errors

The table below lists all possible errors. Errors are situations where the charge controller has stopped itself from operating because of a problem.

Table 15 Error messages

<p><b>Display Text (Description)</b></p>	<p><b>Error ID</b></p>	<p><b>Definition</b></p>
<p>CapOTErr (Capacitor over temperature error)</p>	<p>F2</p>	<p>Output capacitor temperature has risen above 100°C (212°F) for 5 seconds. The error clears itself when the capacitor temperature falls below 90°C (194°F) for 30 seconds. This error should not normally occur. If it is triggered multiple times, the charge controller must be serviced.</p>
<p>BattOTErr (Battery over temperature error)</p>	<p>F4</p>	<p>Battery temperature has risen above 60°C (140°F) for 30 seconds. The error clears itself when the battery temperature falls below 55°C (131°F) for 30 seconds.</p>
<p>AmbOTErr (Ambient over temperature error)</p>	<p>F5</p>	<p>Ambient temperature inside the charge controller has risen above 80°C (176°F) for 5 seconds. The error clears itself when the ambient temperature falls below 65°C (149°F) for 30 seconds.</p>
<p>InputOVerErr (Input over voltage error)</p>	<p>F9</p>	<p>Input voltage has exceeded the input over voltage shut off value, 550 V. The error clears itself when the input voltage falls below the input over voltage restart value, 540 V.</p>
<p>OutputUVImmErr (Output under voltage immediate error)</p>	<p>F10</p>	<p>Output voltage has fallen below 15.8 VDC. The error clears itself when the voltage rises above 19.0 VDC for 1 second.</p>
<p>OutputUVErr (Output under voltage error)</p>	<p>F11</p>	<p><b>24 V System:</b> Output voltage has fallen below 18.0 VDC. The error clears itself when the voltage rises above 19.0 VDC for 1 second. <b>48 V System:</b> Output voltage has fallen below 36.0 VDC. The error clears itself when the voltage rises above 38.0 VDC for 1 second.</p>

AuxPSErr Auxiliary power supply error	F26	Auxiliary power supply is not within its expected operating range. The error clears itself after 1 second and the auxiliary power supply will attempt to restart.
HsOTErr (Heat sink over temperature error)	F55	Heat sink temperature has risen above 82°C (180°F) for 5 seconds. The error clears itself when the heat sink temperature falls below 70°C (158°F) for 30 seconds.
SetupErr	F69	Multiple charge controllers connected to the Xanbus network have the same device number. The error will clear when the operator changes the device numbers of the duplicate charge controllers. The device number can be changed in the Multi Unit Config screen of the SCP.
OutputOVERr (Output over voltage error)	F70	<b>24 V System:</b> Output voltage has risen above 34.5 VDC for 1 second. The error clears itself when the voltage falls below 32.0 VDC for 1 second. <b>48 V System:</b> Output voltage has risen above 69.0 VDC for 1 second. The error clears itself when the voltage falls below 64.0 VDC for 1 second.
OutputFastOCerr (Fast output over current error)	F71	Appears immediately when output current rises above 140 ADC. The error clears itself after 5 seconds. If the error is triggered three times within 60 seconds, then it trips F78, which must be cleared manually.
OutputSlowOCerr (Slow output over current error)	F73	Output current has risen above 115A (Conext MPPT 100 600) or 90A (Conext MPPT 80 600) for 10 milliseconds. The error clears itself after 5 seconds. If this error is triggered three times within 60 seconds, then it trips F78, which must be cleared manually.
FanOCerr (Fan over current error)	F76	Fan current has risen above 1.3 A for 500 milliseconds. The error clears itself when fan current falls below 1.1 A for 1 second.
InputOCerr (Input over current error)	F77	PV current has risen above 32 ADC (Conext MPPT 100 600) or 25 ADC (Conext MPPT 80 600). The error clears itself after 5 seconds and the unit will attempt to restart.
Heartbeat BMS Lost (BMS heartbeat timeout)	F90	When in Heartbeat BMS Mode, the Li-ion battery BMS is or has been disconnected. The error clears itself after the BMS is reconnected.

## Warnings

The following table lists all possible warnings. Warnings indicate that one of the charge controller's operating parameters is approaching the specified limits for the device.

Table 16 Warning messages

Display Text (Description)	Warning ID	Definition
BattOTWrn (Battery over temperature warning)	W4	Battery temperature has risen above 55°C (131°F) for 10 seconds. The warning clears itself when the battery temperature falls below 50°C (122°F) for 10 seconds.
AmbOTWrn (Ambient over temperature warning)	W5	Ambient temperature inside the charge controller has risen above 70°C (158°F) for 10 seconds. The warning clears itself when the ambient temperature falls below 65°C (149°F) for 10 seconds.
BattUTWrn (Battery under temperature warning)	W9	Battery temperature has fallen below -20°C (-4°F) for 10 seconds. The warning clears itself when the battery temperature rises above -10°C (14°F) for 10 seconds.
InputOVWrn Input over voltage warning	W11	This warning occurs when the input voltage is 540 V or above. The warning clears itself when the voltage falls to 530 V.
OutputUVWrn (Output under voltage warning)	W12	<b>24 V System:</b> Output voltage has fallen below 20.0 VDC for 10 seconds. The warning clears itself when the voltage rises above 21.0 VDC for 10 seconds. <b>48 V System:</b> Output voltage has fallen below 40.0 VDC for 10 seconds. The warning clears itself when the voltage rises above 42.0 VDC for 10 seconds.
OutputOVWrn (Output over voltage warning)	W34	<b>24 V System:</b> Output voltage has risen above 33.0 VDC for 10 seconds. The warning clears itself when the voltage falls below 31.0 VDC for 10 seconds. <b>48 V System:</b> Output voltage has risen above 66.0 VDC for 10 seconds. The warning clears itself when the voltage falls below 62.0 VDC for 10 seconds.
HsOTWrn (Heat sink over temperature warning)	W35	Heat sink temperature has risen above 75°C (167°F) for 10 seconds. The warning clears itself when the heat sink temperature falls below 70°C (158°F) for 10 seconds.
HtSnkSnsErr (Heat sink temperature sensor error)	W36	The warning clears itself when the heat sink sensor temperature falls within normal range. If the error persists, contact your installer for a possible replacement.

BrdSnrErr (Boardtemperature sensor error)	W37	The warning clears itself when the board sensor temperature falls within normal range. If the error persists, contact your installer for a possible replacement.
CapSnrErr (Capacitor temperature sensor error)	W38	The warning clears itself when the capacitor sensor temperature falls within normal range. If the error persists, contact your installer for a possible replacement.

## Viewing Fault, Error, and Warning Logs

The SCP displays fault, error, and warning logs stored on the charge controller.

*Table 17 History menu items*

SCP Device Menu	Item	Description
Setup > View Device Info	View Fault Log	Displays a log of the faults and errors.
Setup > View Device Info	View Warning Log	Displays a log of the warnings.

- To view the fault and error logs, go to **Setup > View Device Info > View Fault Log**.
- To view the warning logs, go to **Setup > View Device Info > View Warning Log**.

Press the down arrow to view all the entries in the log. The entries are listed chronologically, with the most recent fault, error, or warning at the top of the list. The fault, error, or warning number, date, and time are displayed. Press **Enter** to view details for a particular entry, including the name. The twenty most recent entries are stored.

## Viewing Harvest Logs

The SCP displays the daily, monthly, and yearly performance logs stored on the charge controller.

**Note:**

To record monthly and yearly logs, the charge controller must be connected to a real-time clock source. Make sure the charge controller is attached to the Xanbus network with at least one of the following:

- Conext XW+ or Conext XW Pro Inverter/Charger
- Conext System Control Panel
- Conext Gateway

Table 18 Harvest logs menu items

SCP Device Menu	Item	Description
Setup > Harvest Logs	Daily Logs	Displays a log of the charge controller's amp-hour and kilowatt-hour production for the day as well as the peak power output and time in float for the day.
Setup > Harvest Logs	Monthly Logs	Displays a log of the aggregate total for amp hours and kilowatt hours produced during the month as well as the peak power output and time in float for the month.
Setup > Harvest Logs	Yearly Logs	Displays a log of the aggregate total for amp hours and kilowatt hours produced during the year as well as the peak power output and time in float for the year.

### Daily Logs

To view the daily logs, go to **Setup > Harvest Logs**. From the Daily Logs screen, press Enter. Press the down arrow button to scroll through the daily logs, starting with the current date. The charge controller stores up to 62 daily logs.

After 62 days, the oldest daily log is overwritten.

### Monthly Logs

To view the monthly logs, go to **Setup > Harvest Logs**. From the Monthly Logs screen, press Enter. Press the down arrow button to scroll through the monthly logs, starting with the current month. The charge controller stores up to 24 monthly logs. After 24 months, the oldest monthly log is overwritten.

### Yearly Logs

To view the yearly logs, go to **Setup > Harvest Logs**. From the Yearly Logs screen, press **Enter**. Press the down arrow button to scroll through the yearly logs, starting with

the current year. The charge controller stores up to 12 yearly logs. After 12 years, the oldest yearly log is overwritten.

## Equalizing Batteries

Equalization charging is the process of deliberately charging a battery or battery bank at a high voltage for a set period of time. Equalize charging remixes the electrolyte, helps to remove sulfate buildup on the battery plates, and balances the charge of individual cells.

Make sure to read all cautions and warnings regarding equalization charging batteries before allowing an equalization charge to occur.

**Note:** In a system where more than one device is capable of equalizing batteries (such as a system including multiple charge controllers and Conext XW+ or Conext XW Pro Inverter/Charger), there is no system-wide equalization command for all devices. To equalize with multiple devices, each would have to be enabled individually. Alternatively, equalization can be performed using only one device. During the equalization process, one device applies the equalization charge while the other devices continue to operate in synchronized charge mode, typically in float (three-stage charging) or no float (two-stage charging).

### **WARNING**

#### **HAZARD OF EXPLOSION**

Equalization charging generates explosive gases which might escape from the battery. Make sure adequate ventilation is provided. Never leave a battery unattended during equalization. Follow the battery manufacturer's recommended actions for determining the appropriate point at which to stop the equalization process, for example, by monitoring electrolyte specific gravity.

**Failure to follow these instructions can result in death, serious injury, or equipment damage.**

### **NOTICE**

#### **BATTERY DAMAGE**

Never equalize a battery more than necessary. Equalization can damage your batteries if performed too frequently or done improperly. Always check electrolyte level before and after equalization. Fill with distilled water according to the battery manufacturer's recommendation.

The charge controller enables equalization only when the battery type is set to Flooded. Equalize mode is disabled if you have selected GEL and AGM as the battery type. As a general rule, do not equalize a battery unless there are provisions to add water to it and the manufacturer recommends equalization.

**Failure to follow these instructions can result in equipment damage.**



## ***NOTICE***

### **DC LOAD EQUIPMENT DAMAGE**

Equalization voltage could be as high as 33.5V (for 24V systems) or 67V (for 48V systems) and might damage some types of DC load equipment connected to the battery. Review the maximum DC voltage specification for all equipment connected to the DC system and disconnect any equipment that is not compatible with the configured equalize voltage.

**Failure to follow these instructions can result in equipment damage.**

**Note:** The Conext XW+ or Conext XW Pro Inverter/Charger and PDP will not be damaged by equalization voltage and do not need to be disconnected during equalization. However, these units may shut down depending on the setting of their over voltage protection trip points.

Follow the battery manufacturer's recommendations for equalizing your batteries. As a guide, a heavily used flooded battery might need to be equalized once a month, while a battery in light service might only need to be equalized every two to four months.

The equalization process lasts one hour. When the equalization period has expired, the charge controller will return to either the float or no float charge stage.

#### **To enable battery equalization:**

- On the *Setup* menu screen scroll to *Equalize*, and then press **Enter**.
- Change the setting to *Enabled*.

The charge controller goes back to the bulk stage and goes through bulk and absorption before entering the equalization stage. The full charge cycle makes sure the batteries are fully charged before an equalization is initiated.

The charge controller applies the equalization charge for one hour. You can stop the equalization process manually at any time by changing the setting to *Disabled*.

The one hour equalization timer will continue to run even if there is insufficient power from the PV array to support this charge mode.

#### **To determine when battery equalization is complete:**

Follow the battery manufacturer's recommendations for equalizing the batteries. These recommendations will include methods such as monitoring the specific gravity (SG) of the electrolyte using a battery hygrometer and stopping the equalization when the SG has stopped increasing.

- If the recommended point is reached before the automatic one hour equalization timer runs out, then manually stop the equalization by changing the setting to *Disabled*.
- If the recommended point is not reached after one hour, the charge controller will automatically exit the equalization stage. You can re-start equalization by following the process above and continue equalizing until the battery manufacturer's recommendation is met.

**To manually stop battery equalization:**

- On the Setup Menu, scroll to **Equalize**, and then press **Enter**.
- Change the setting to **Disabled**.

Equalization stops, and the charge controller goes to either the float or no float stage, depending on the charge mode selected.

## Remote Power Off (RPO)

It is possible to immediately stop the operation of the charge controller by adding a remote power off (RPO) switch via the Conext XW+ or Conext XW Pro Inverter/Charger's AUX port.

When activated, Xanbus devices such as the Conext XW+ or Conext XW Pro Inverter/Charger and the charge controller will stop all operation, including solar charging, effectively transitioning the power system into a standby mode.

For information on the different modes, see *Configuring Device Settings on page 40*.

 **DANGER****HAZARD OF ELECTRIC SHOCK, EXPLOSION, OR ARC FLASH**

- Do not attempt to service, maintain, or troubleshoot the Solar Charge Controller after activating an RPO switch.
- Disconnect PV conductors before servicing. PV conductors are to be treated as Hazardous Live and must be disconnected.
- Normally GROUNDED conductors may be UNGROUNDED and ENERGIZED when a GROUND FAULT is indicated on the front panel. Must be serviced by qualified personnel.

**Failure to follow these instructions will result in death or serious injury.**



## 4 Troubleshooting

What's in This Chapter?

<b>Troubleshooting</b> .....	<b>60</b>
------------------------------	-----------

# Troubleshooting

Table 19 Charge controller troubleshooting

Issue	Possible Cause	Solution
Battery voltage is exceeding bulk and float settings in cold weather and not reaching settings in hot weather.	The BTS is compensating charging voltages based on battery temperature.	No problem. This is the intended operation.
The charge controller's Error/Warning (red) LED is on or flashing.	An active fault, error, or warning is present on the charge controller.	See <i>Viewing Active Faults, Errors, and Warnings</i> on page 48 to determine which alarm is active on the charge controller. The tables in this section provide detailed information on why various alarms could be occurring on the charge controller.
Battery equalization was enabled but did not occur.	The charge controller must complete a bulk/absorption cycle before it can initiate an equalization cycle.	See <i>Equalizing Batteries</i> on page 55 for information on equalization charging. See <i>Viewing Status Information on the Charge Controller</i> on page 44 for information on determining the status of the equalization cycle.
BTS information does not show up on the charge controller's Meters screen on the SCP.	The BTS reading is only shown on the Meters screen if the BTS is physically connected to the device you are viewing on the SCP. All devices share BTS information, but they only report the information to the SCP if they have the BTS plugged into their BTS port.	Navigate to the Meters screen on the SCP for the device that has the BTS connected to it.
Thermal derating is indicated on the SCP.	<p>The charge controller is operating in a high ambient temperature environment at high power levels.</p> <p>The fans are not working properly.</p>	<p>The charge controller is specified to operate at full output power up to 40°C. Derating occurs at temperatures above this level.</p> <p>Make sure that you have not blocked the ventilation holes at the top and bottom of the charge controller and that you have provided sufficient clearance for proper ventilation of the charge controller. Check the active fault list and the historical fault log on the SCP to see if the charge controller has registered any faults or errors related to fan operation.</p>

<p>The charge controller's Error/ Warning (red) LED is on, and the SCP indicates an input over voltage error (F9) for the charge controller.</p>	<p>The PV panels are producing voltage levels that are outside the operating specifications for the charge controller. This is likely due to the panels experiencing extreme cold temperatures for the region.</p>	<p>This condition will correct itself when the panels warm up and the voltage decreases to within operating specifications. If it occurs regularly, then the installation likely has too many PV panels in series and might need reconfiguration to lower the voltage to the charge controller. See <i>Electrical Specifications on page 64</i> for details on the charge controller's operating range.</p>
<p>The charge controller's On/ Charging (green) LED is flashing.</p>	<p>The charge controller is outputting charge current.</p>	<p>No problem. This is intended operation. See <i>Viewing Status Information on the Charge Controller on page 44</i> for LED status information.</p>
<p>The SCP turns off completely after sunset.</p>	<p>The SCP is powered by the output of the charge controller, and it has been configured to turn off the Solar Charge Controller power supply during the night.</p>	<p>See <i>Reducing Tare Loss on page 42</i> for more information on disabling certain power supplies at night to reduce night time tare losses.</p>
<p>The charge controller's Error/ Warning (red) LED is on, and the SCP is blank.</p>	<p>The network power supply fault (F82) has been triggered and has disrupted power to the SCP.</p>	<p>Remove power to the charge controller by opening the PV and battery disconnects long enough for the red and green LEDs to turn off. Restore power by closing the PV and battery disconnects, and then confirm that the SCP resumes operation.  Contact customer service if the issue is not resolved.</p>
<p>The system is very slow to respond, does not update data, takes a long time to start unit when applying PV voltage.</p>	<p>Low Power (Night) mode is selected and PV voltage at the unit is low (below 195V) or disconnected. In this case the unit wakes up to check PV voltage and transmit data on Xanbus once every 2 minutes and goes back to sleep if the PV voltage is still low.</p>	<p>Low power mode is enabled by default from the factory. This mode can be disabled under <b>Advanced Features</b> on the SCP. When disabled, the unit will remain awake and responsive as long as battery voltage is present. Note that this increases power consumption at night.</p>



# A Specifications

## What's in This Chapter?

<b>Electrical Specifications</b> .....	<b>64</b>
MPPT Voltage Range .....	65
Operating Below the PV Array Voltage Full Power Range .....	66
Conext MPPT 80 600 .....	66
Conext MPPT 100 600 .....	66
<b>Default Battery Charging Settings</b> .....	<b>67</b>
<b>Mechanical Specifications</b> .....	<b>68</b>
<b>Output Power Versus Ambient Temperature</b> .....	<b>69</b>
<b>Accessories</b> .....	<b>70</b>
Conext System Control Panel .....	70
Conext Gateway .....	70
Conext Config Tool .....	70
<b>Regulatory Approvals</b> .....	<b>71</b>



# Electrical Specifications

**Note:** All specifications are subject to change without notice.

Table 20 Electrical specifications

Specification	Conext MPPT 80 600	Conext MPPT 100 600
Maximum PV Array Open Circuit Voltage	600 VDC	
PV Array Voltage Operating Range	195 to 550 VDC	
PV Array Voltage Full Power Range <sup>1</sup>	230 to 550 VDC	
Maximum Power Point Tracking Range	195 to 510 VDC	
PV Input Start Voltage	230 VDC <sup>2</sup>	
Maximum Operating Current	23 A	29 A
Maximum Permissible Array Short Circuit Current at STC	28 A	35 A
Nominal Battery Voltages	24 and 48 VDC (Default is 48 V)	
Battery Voltage Operating Range	16 to 67 VDC	
Maximum Charging Current	80 A	100 A
Maximum Charging Power (at 30 V, nominal 24 V battery bank)	2400 W	3000 W
(at 60 V, nominal 48 V battery bank)	4800 W	6000 W
Maximum Power Conversion Efficiency (nominal 24 V battery bank)	92%	
(nominal 48 V battery bank)	95%	
Auxiliary Output	Dry contact switching up to 60 VDC, 30 VAC, 8 A	
Charger Regulation Method	Three stage (bulk, absorption, float) Two stage (bulk, absorption) Manual equalization	
Tare Losses <sup>3</sup>	Less than 1.0 W (Xanbus power supply on) Less than 0.5 W (Xanbus power supply off)	

<sup>1</sup> Full power output below 230 V is not assured. See *Operating Below the PV Array Voltage Full Power Range* on page 66 for more information.

<sup>2</sup> Charging does not begin until input voltage exceeds 230 V. Once charging has started, it will continue until the input voltage falls below 195 V.

<sup>3</sup> These values are based on the following specifications: a) The battery voltage is 48 V, and b) "Lo Pwr at Night" enabled. See *Reducing Tare Loss* on page 42 for more information.

**Note:**

- PV array voltages often exceed STC voltage specifications, especially when the array is cold. At cold temperatures the open circuit voltage will be higher than at STC or MPPT operating points. Refer to data provided by the maker of the PV panels and ensure the maximum voltage can never exceed the limits in the table above.
- PV array current might exceed STC current specifications, especially under intense sunlight, certain atmospheric conditions, or from reflections (i.e. water, snow, or ice). Some electrical codes (eg. the NEC) consider the worst case current to be 25% higher than the short circuit current at STC. For selection of wire and some components (breakers, fuses) a further 25% derating is applied.

## MPPT Voltage Range

The charge controller's Maximum Power Point Tracking (MPPT) algorithm maximizes the output energy of PV arrays as long as the operating voltage is within the MPPT operational window. The MPPT operational window is shown below.

***NOTICE***

**EQUIPMENT DAMAGE**

Make sure that the PV arrays have been designed to always operate within the MPPT operational window (0 to 600 V).

**Failure to follow these instructions can result in equipment damage.**

*Figure 9 MPPT Operational Window*

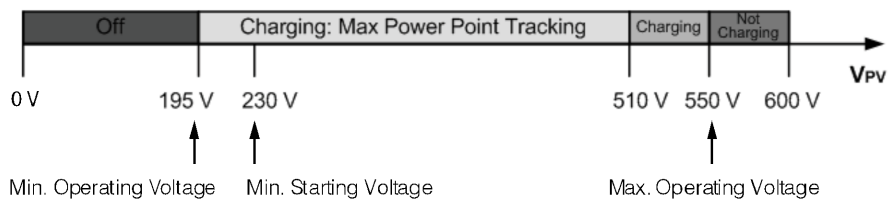

## Operating Below the PV Array Voltage Full Power Range

When the charge controller is used on a 48 V battery bank and a PV array where the MPP is below 230 V, full output power is not assured. The figures below show the maximum output current and maximum output power that can be produced when the charge controller is operating below 230 V. The actual amount of current and power that your charge controller can produce below 230 V will depend on the actual battery voltage and the amount of solar power available from your panels. Full output current is available on 24 V battery systems across the entire input voltage operating range.

### Conext MPPT 80 600

Figure 10 Maximum Expected Output Current Versus Input Voltage, Conext MPPT 80 600

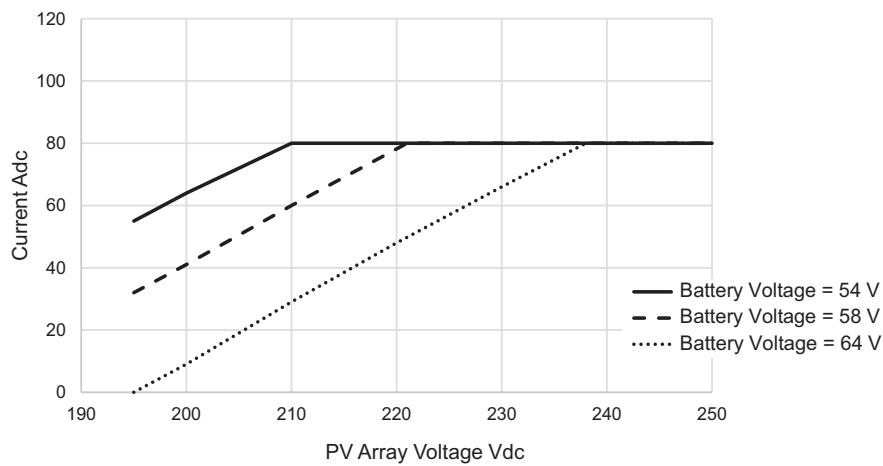

### Conext MPPT 100 600

Figure 11 Maximum Expected Output Current Versus Input Voltage, Conext MPPT 100 600

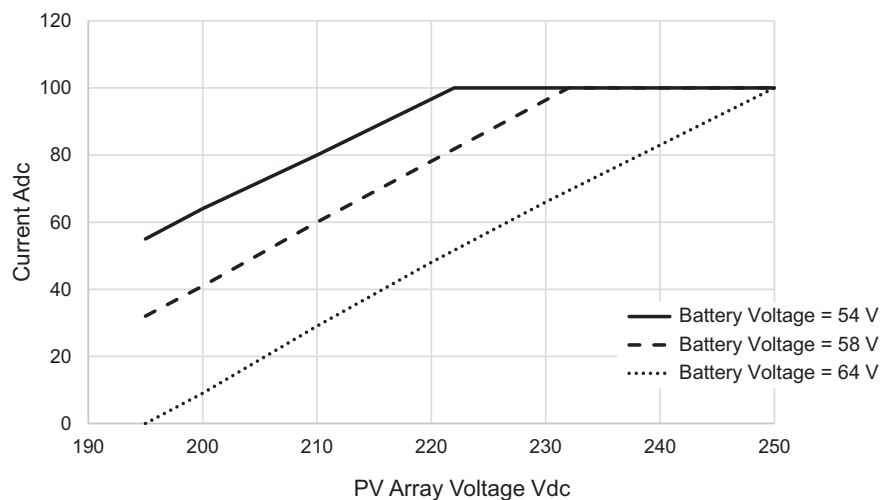

## Default Battery Charging Settings

All settings in the following table are based on a 48 V nominal battery bank at 25°C (77°F). For a 24 V nominal battery bank, divide the voltage values in this table by two.

Setting	Battery Type		
	Flooded <sup>1</sup>	Gel	AGM
Equalize Voltage	64.0 V	n/a	n/a
ReCharge Voltage	50.0 V	50.0 V	50.0 V
Bulk Voltage	57.6 V	56.8 V	57.2 V
Absorption Voltage	57.6 V	56.8 V	57.2 V
Float Voltage	54.0 V	55.2 V	53.6 V
Absorption Time	180 min	180 min	180 min
Batt Temp Comp	-108 mV/C	-108 mV/C	-84 mV/C

<sup>1</sup> When **Custom** is selected for the battery type, the default settings are based on the flooded battery type.

## Mechanical Specifications

Table 21 Mechanical specifications

Enclosure Type	IP20, indoor, ventilated, aluminum sheet metal chassis with 7/8" and 1" (22.22 mm and 27.76 mm) knockouts and aluminum heat sink
Maximum and Minimum Wire Size in Conduit	#6 AWG to #14 AWG (13.5 to 2.5 mm <sup>2</sup> )
Maximum and Minimum Wire Size Rating of PV Terminal Block	#6 AWG to #14 AWG (13.5 to 2.5 mm <sup>2</sup> )
Maximum and Minimum Wire Size Rating of Battery Terminal Block	#2 AWG to #14 AWG (35 to 2.5 mm <sup>2</sup> )
Wire Size Rating of Auxiliary Output Connector	#16 AWG (1.5 mm <sup>2</sup> )
Operating Temperature Range	-20 to +65°C (-4 to 149°F) (derate above 40°C, see <i>Figure 12</i> )
Storage Temperature	-40 to +85°C (-40 to 185°F)
Pollution degree	2
Over voltage category	CAT II
Altitude Limit (operating)	Sea level to 6,500 feet (approximately 2000 m) recommended
Unit Dimensions (H × W × D)	30 × 8 5/8 × 8 5/8" (760 × 220 × 220 mm)
Mounting	Vertical wall mount
Weight (charge controller only)	29.8 lb (13.5 kg)
Weight (shipping)	45 lb (20.4 kg)

## Output Power Versus Ambient Temperature

Once the charge controller's heat sink reaches maximum full-power operating temperature, the charge controller reduces its power output to ensure component ratings are not exceeded.

Figure 12 Output power vs. ambient temperature, Conext MPPT 80 600

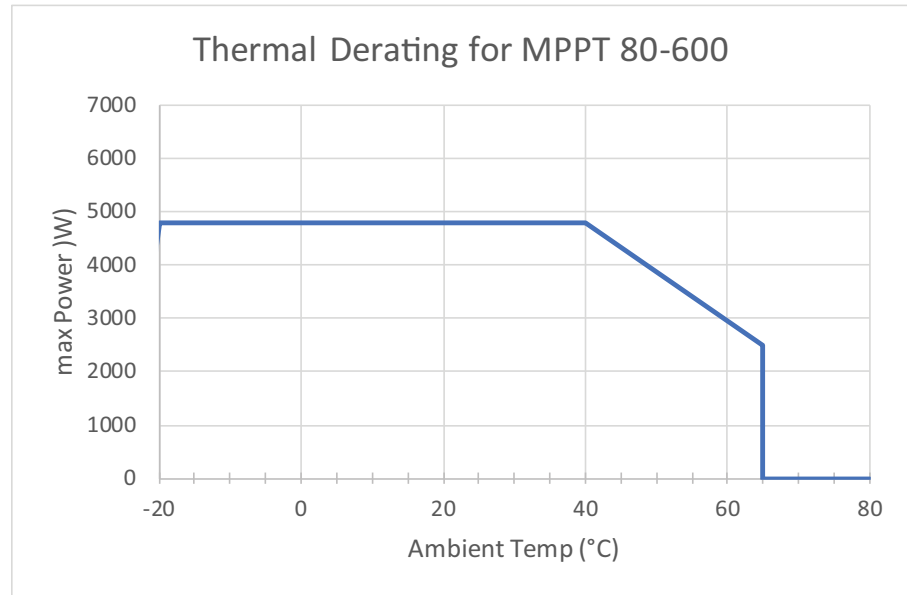
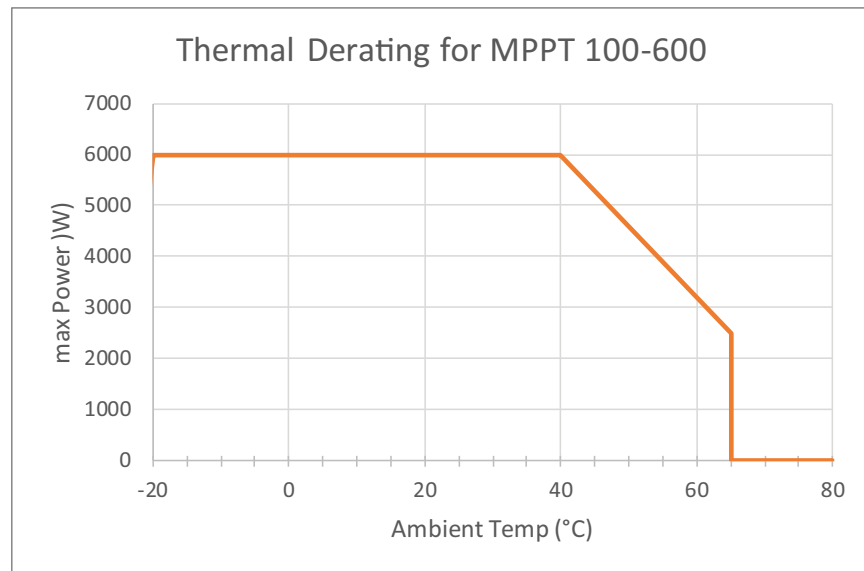

Figure 13 Output power vs. ambient temperature, Conext MPPT 100 600



## Accessories

### Conext System Control Panel

The Conext System Control Panel (SCP) (Part Number 865-1050) is required for installation of the charge controller and is strongly recommended for ongoing operation.

As the primary interface to the charge controller, the SCP is used for setup and configuration. Once installation is complete, you can use the SCP for monitoring and fault reporting. Only one SCP is required to monitor multiple charge controllers.

**Note:** You must use the SCP with firmware version 1.05.00 or higher for full compatibility with the charge controller. For information on updating your firmware, contact customer service. The Conext Config Tool or Conext Gateway is required for upgrading.

### Conext Gateway

In place of the SCP, the Conext Gateway (Part Number 865-0329) can also be used. The Conext Gateway allows you to configure and monitor the charge controller through a web interface on a PC or laptop. See the *Conext Gateway Owner's Guide (975-0806-01-xx)*.

### Conext Config Tool

The Conext Config Tool (Part Number 865-1155) is a commissioning tool used for configuring or upgrading a Conext system.

## Regulatory Approvals

**Certified to UL 1741 and to CSA 107.1 and carries the c(CSA)us mark. EMC - North America:**

- FCC Part-15 sub part B, Class B, emission limits
- Industry Canada ICES-003, Class B, emission limits

**CE Marked and complies with the following:**

Low Voltage Directive 2014/35/EU, per:

- EN/IEC 62109-1: safety of power converters used in photovoltaic systems

EMC Directive 2014/30/EU, per:

- EN61000-6-3 Emission standard for residential, commercial, and light- industrial environments
- EN61000-6-1 Immunity for residential, commercial, and light-industrial environments

**Australia:**

- RCM mark





## B Conext System Control Panel Menus

### What's in This Chapter?

<b>Using the System Control Panel (SCP)</b> .....	<b>74</b>
SCP Menu Map .....	75
Changing Settings Using the SCP .....	76
Viewing the Select Device Menu .....	76
Viewing the Setup Menu .....	76
The Setup Menu .....	77
<b>Configuration Settings</b> .....	<b>78</b>
<b>Monitoring the Unit</b> .....	<b>81</b>

## Using the System Control Panel (SCP)

**Note:** The images below are for illustrative purposes only. The information displayed on the menu screens will vary depending on the charge controller model (Conext MPPT 80 600 or Conext MPPT 100 600).

The charge controller is configured using the Conext System Control Panel (SCP). The SCP has four buttons for navigating between screens and menus and configuring the charge controller. See *Figure 14* and *Table 22*.

*Figure 14 Conext System Control Panel*

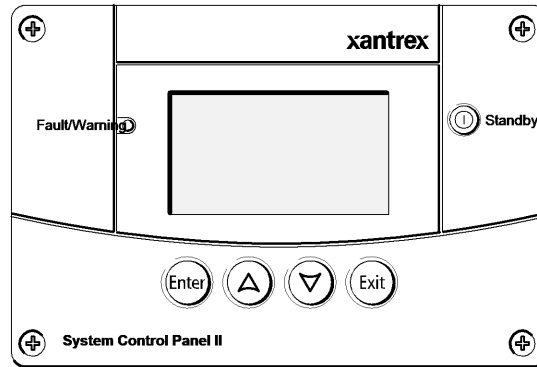

*Table 22 Conext System Control Panel navigation buttons*

Button	Function
Enter	Confirms selection of a menu item
	Displays the next screen
Up	Scrolls up one line of text
	Increases a selected value Displays the previous Device Home screen
Down	Scrolls down one line of text
	Decreases a selected value Displays the next Device Home screen
Exit	Cancels selection of a menu item Displays the previous screen

# SCP Menu Map

The figure below shows how the SCP screens and menus are organized. The screens and menus are described in the following table.

Figure 15 Screen and menu descriptions

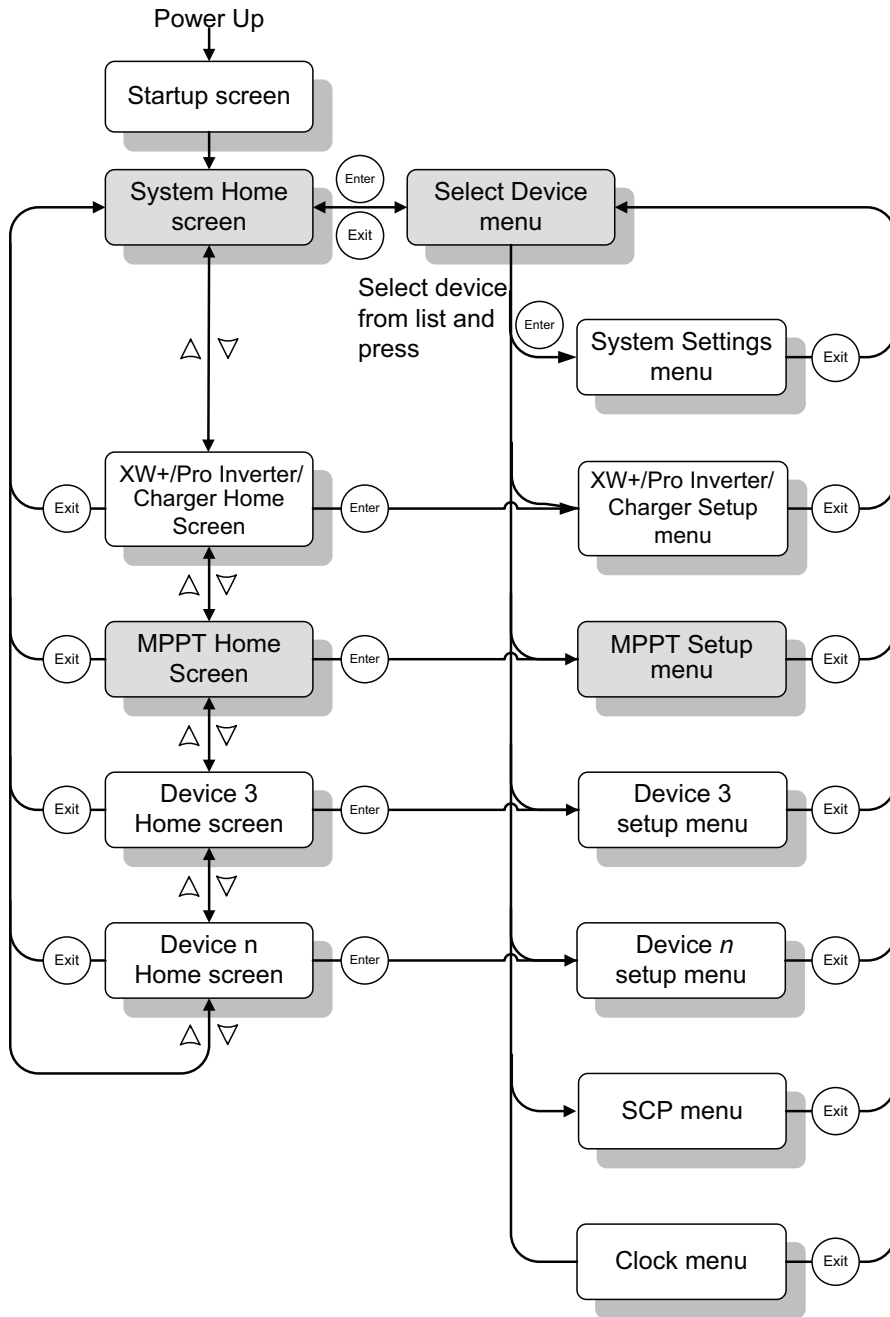

Screen or menu	Description
Startup screen	Appears for a few seconds after the system starts up or when the system has been reset.

System Status screen	Displays status information for the power system, consisting of all Xanbus- connected devices on a single network. The <i>System Status</i> home screen appearance varies with the status of the Conext XW+ or Conext XW Pro Inverter/Charger and other Xanbus-enabled devices in the power system. The <i>System Status</i> home screen features a menu arrow pointing to the <b>Enter</b> button. Pressing <b>Enter</b> takes you to the <i>Select Device</i> menu.
XW MPPT Home screen	Displays status information for the charge controller.
Select Device menu	Displays a list of Xanbus-enabled devices in the system, including the charge controller and the SCP. The length of this menu depends on how many Xanbus- enabled devices are installed in the system. This menu also contains the clock menu (where you can set the time and date) and the system settings menu (where you can change system modes). The <i>System Panel</i> , <i>Clock</i> , and <i>System Settings</i> menu items are available from the Select Device menu, regardless of the number of Xanbus-enabled devices installed.
XW MPPT Setup menu	Displays status information and changeable settings. Changeable settings are identified by square brackets [ ] around values in the right-hand column.

## Changing Settings Using the SCP

To change a charge controller's setting, use the buttons on the SCP to perform three basic steps:

- View the *Select Device* menu.
- Select the charge controller from the *Select Device* menu.
- Select and adjust a changeable setting on the charge controller's *Setup* menu. See *Configuration Settings on page 78*.

Each of these three steps is described in detail in the following sections.

**Note:** You can also view the charge controller's Setup menu by pressing Enter from the charge controller's home screen. See "Home Screen" in *Monitoring the Unit on page 81*.

## Viewing the Select Device Menu

The Select Device menu is where you select a Xanbus-enabled device to monitor or configure. The number of items on the Select Device menu depends on how many devices are installed in your system.

**To view the Select Device menu:**

- On the *System Status* screen, press **Enter**.

**Note:** You can identify the *System Status* home screen by the menu arrow in the bottom left corner of the screen. The menu arrow indicates the **Enter** button on the SCP, which you press to view the *Select Device* menu.

## Viewing the Setup Menu

On the *Select Device* menu, select the charge controller to view and change its settings.

Figure 16 Selecting the unit

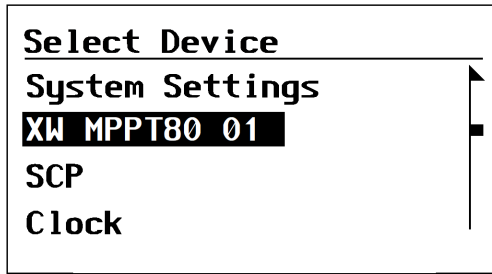

To select the charge controller from the **Select Device** menu:

- Press the down arrow button to highlight **XW MPPT80 xx**, where **xx** is the device number.
- Press **Enter**.  
The *Setup* menu appears.

## The Setup Menu

The *Setup* menu allows access to the *Meters* screen and several other commands that control the charge controller's operation.

Figure 17 Setup menu

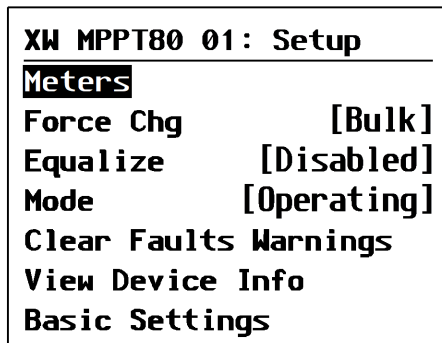

Table 23 Setup menu

Menu Item	Description
Meters	Displays the <i>Meters</i> screen.
Harvest Logs	Displays the charge controller's daily, monthly, and yearly performance logs. See "Viewing Harvest Logs" in <i>Viewing Fault, Error, and Warning Logs on page 53</i> .
Force Chg	Causes the current charge stage to change to the selected stage.
Equalize	Starts or stops battery equalization.
Mode	Sets the charge controller's operating mode.
Clear Faults Warnings	Clears any active faults or warnings. If the fault or warning condition is still present, the fault or warning message could reappear.
View Device Info	Displays the <i>Dev Info</i> screen. On the <i>Dev Info</i> screen you can view the warning, fault, and event logs.

Basic Settings	Displays the charge controller's basic or advanced configuration settings. To change to advanced settings, press the <b>Enter</b> , up arrow, and down arrow buttons simultaneously.
----------------	--

## Configuration Settings

The configuration settings can be viewed in basic and advanced formats.

### Basic menu

The basic menu contains items you might have to view and adjust on a routine basis.

### Advanced menu

**Note:** The images below are for illustrative purposes only. The information displayed on the menu screens will vary depending on the charge controller model (Conext MPPT 80 600 or Conext MPPT 100 600).

The advanced menu contains items intended for service personnel and one-time setup, such as auxiliary output and custom battery configuration. To display the *Advanced Settings* menu item instead of the *Basic Settings* menu item, perform the following special keypress:

- From the Setup menu, press the Enter, up arrow, and down arrow buttons simultaneously.

On the *Setup* menu, *Basic Settings* disappears from the bottom of the list, and *Advanced Settings* appears at the top of the list.

After configuring the charge controller, help prevent unintended advanced configuration by using the combined keypress again to hide the advanced menu items.

#### Note:

- This keypress displays advanced settings for every device in the system.
- After performing the keypress, Advanced Settings appears at the top of the Setup menu. When the keypress is performed again, the Setup menu displays Basic Settings as the last item on the menu.

The charge controller *Config* menu contains sub-menus for configuring:

- Multiple-unit operation
- Charger and battery settings
- Input settings
- Auxiliary output settings.

#### To view the Config menu:

- From the *Setup* menu, with *Basic Settings* or *Advanced Settings* highlighted, press **Enter**.

Figure 18 Selecting the configure menu

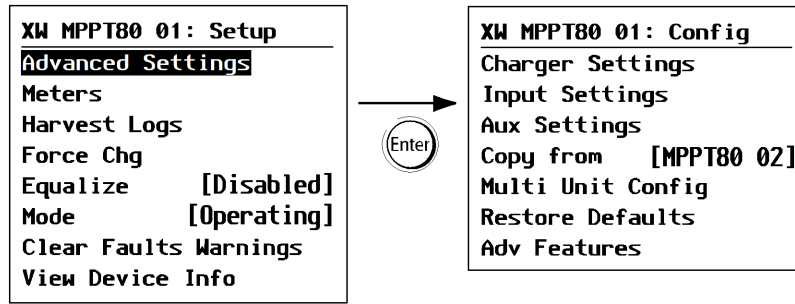

For a map of all configuration menus, see *Monitoring the Unit on page 81*.

Configurable settings are identified by square brackets [ ] around the values along the right side of the screen.

#### To select and change a configurable setting:

1. On the menu, press the up arrow or down arrow button to highlight the setting you want to change.
2. Press **Enter** to highlight the current value of the setting.
3. Press the up arrow or the down arrow button to change the value. Hold down the button to scroll through a large range of values quickly.

The previously set value appears with an asterisk (\*) beside it.

4. Press **Enter** to select the value.

#### To restore the charge controller's default settings:

1. On the *Config* menu, select `Restore Defaults`.
2. Press **Enter**.



Figure 19 Configuration menus (Basic)

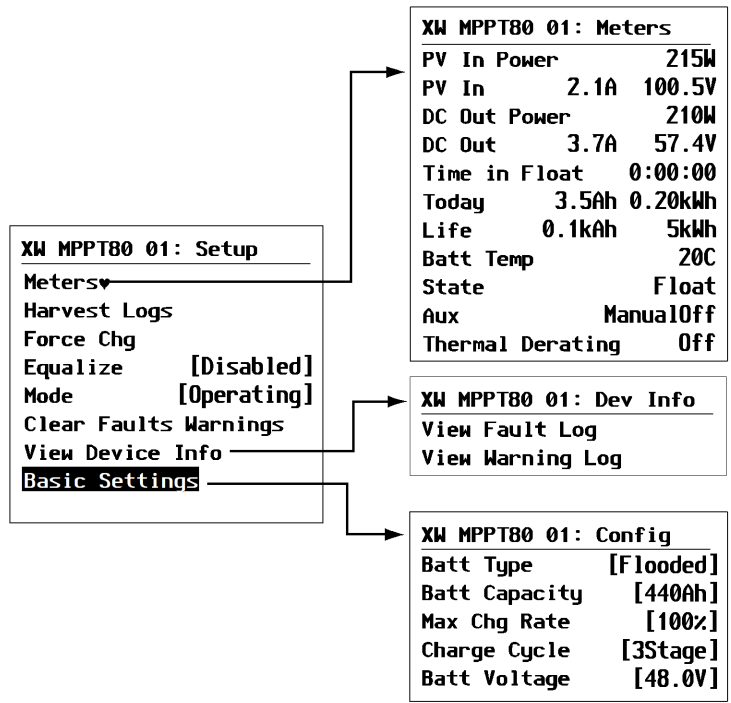
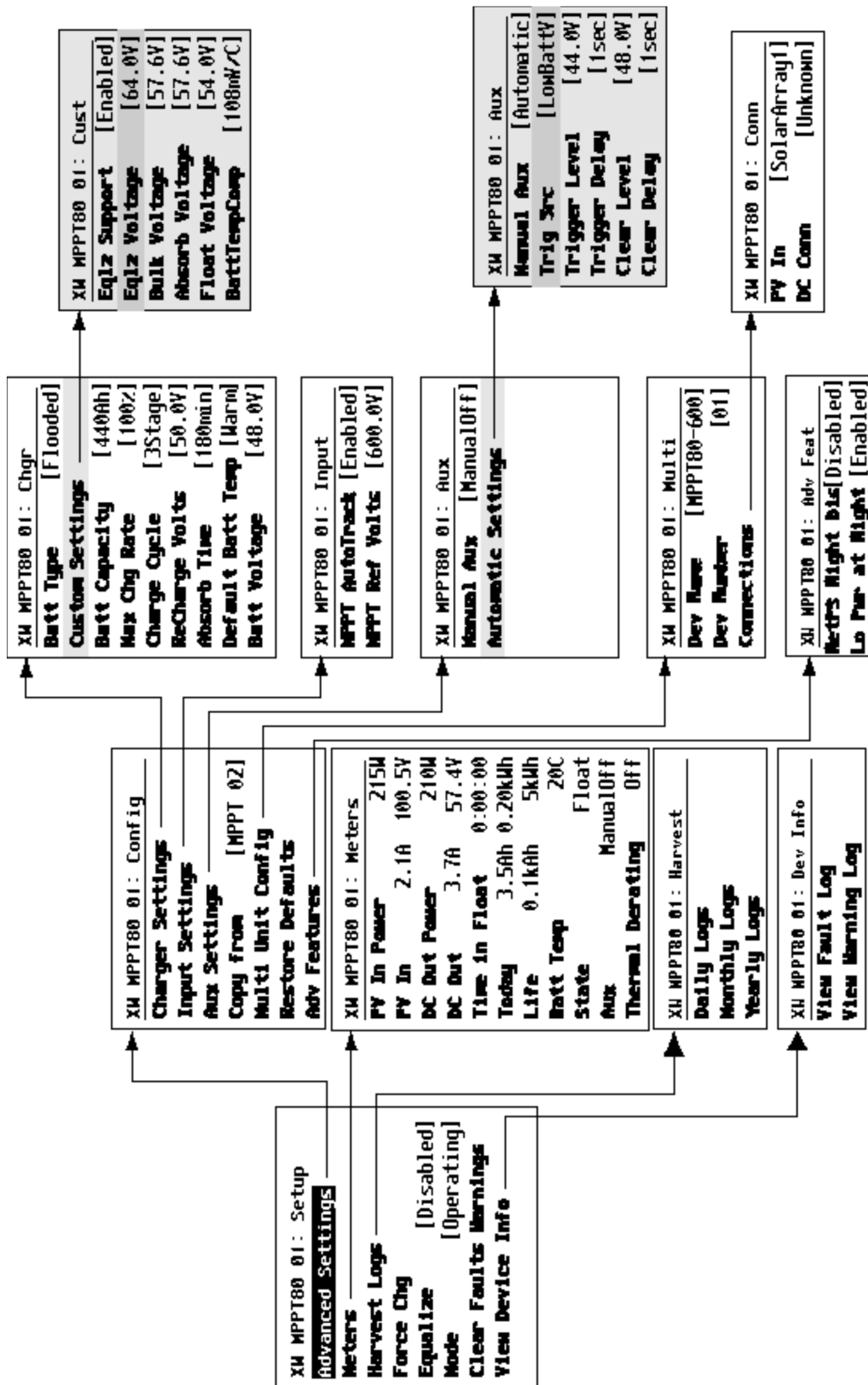

Figure 20 Configuration menus (Advanced)



## Monitoring the Unit

You can monitor the charge controller's operation on the SCP by viewing the:

- *Home* screen
- *Meters* screen

### Home Screen

The charge controller's *Home* screen displays real-time operational data specific to the charge controller.

#### To view the charge controller's Home screen:

- From the *System Status* screen, press the down arrow until the charge controller's *Home* screen appears.

#### To return to the System Status screen:

- Press the **Exit** button.

Figure 21 Home screen

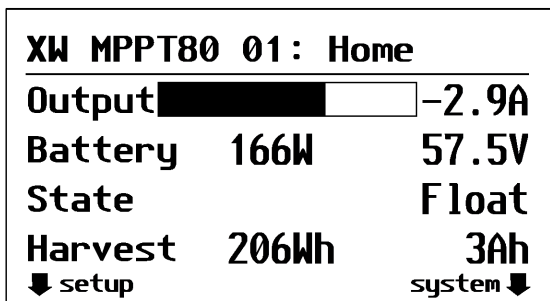

Top Line: Model #, device number
Line 1: Output current to batteries
Line 2: Output power, battery voltage
Line 3: Charge State
Line 4: Output since last sleep period

The charge controller's *Home* screen features a setup arrow pointing to the **Enter** button and a system arrow pointing to the **Exit** button. Pressing **Enter** takes you to the charge controller's *Setup* menu. Pressing **Exit** takes you to the *System Status* screen.

Pressing the down arrow button takes you to the home screens for the other Xanbus-enabled devices in the system.

### Meters

Monitor the charge controller's operation on the *Meters* screen. The *Meters* screen displays input and output power, battery temperature, charge stage, total power production for that day, and power production over the charge controller's lifetime.

You can select the *Meters* screen from the charge controller's *Setup* menu.

Figure 22 Selecting the Meters screen

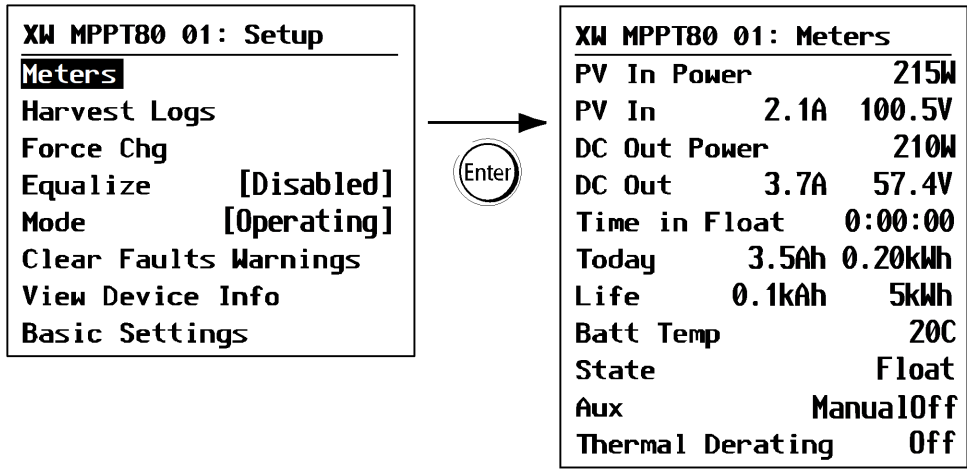



## C Boost Charging

What's in This Chapter?

<b>Using Boost Charging</b> .....	<b>86</b>
-----------------------------------	-----------

## Using Boost Charging

Boost charging allows for better utilization of flooded lead acid batteries under moderate cycling in off-grid applications. Boost charging encourages a short duration charging voltage—above the gassing voltage—at the beginning of the absorption charge state. Testing has shown that boost charging improves battery performance by providing a regular mixing of the liquid electrolyte. Boost charging specifically discourages capacity-robbing acid stratification and plate sulfation.

Boost mode charging can be enabled by selecting the custom battery type and then setting the bulk voltage higher than the absorption voltage. The multi-stage charge algorithm then attempts to use the higher bulk voltage for the first hour of the absorption stage – unless interrupted by the max absorption timer or exit current threshold mechanism.

- Boost charging encourages gassing of flooded lead acid batteries.

### **WARNING**

#### **HAZARD OF EXPLOSION**

Always make sure battery ventilation is adequate, according to the manufacturer's guidelines. Boost charging generates explosive gases which might escape from the battery.

**Failure to follow these instructions can result in death, serious injury, or equipment damage.**

- Boost charging is NOT recommended for AGM, GEL, or any other electrolyte-limited and/or valve regulated sealed battery application.
- Boost charging could result in higher than normal water consumption. However, the benefits of boost charging are likely to be greater than the extra watering effort. Check battery water levels at least once per month.
- Boost charging has maximum benefit when used on batteries that experience moderate cycling. An unoccupied cottage, for example, where batteries are full the majority of the time, might not benefit from boost charging – especially if battery watering is difficult.

## **Schneider Electric**

As standards, specifications, and designs change from time to time, please ask for confirmation of the information given in this publication.

For other country details please contact your local Schneider Electric Sales Representative or visit the Schneider Electric Solar Business website at: <http://solar.schneider-electric.com/>

© 2020 Schneider Electric. All Rights Reserved.